

# EE-293R

## Electronic Shelf Label 2,13”

The EE-293R is a black/white/red e-paper based electronic shelf label with a screen size of 2.9” and with 802.15.4 based wireless communication.

## Specifications manual

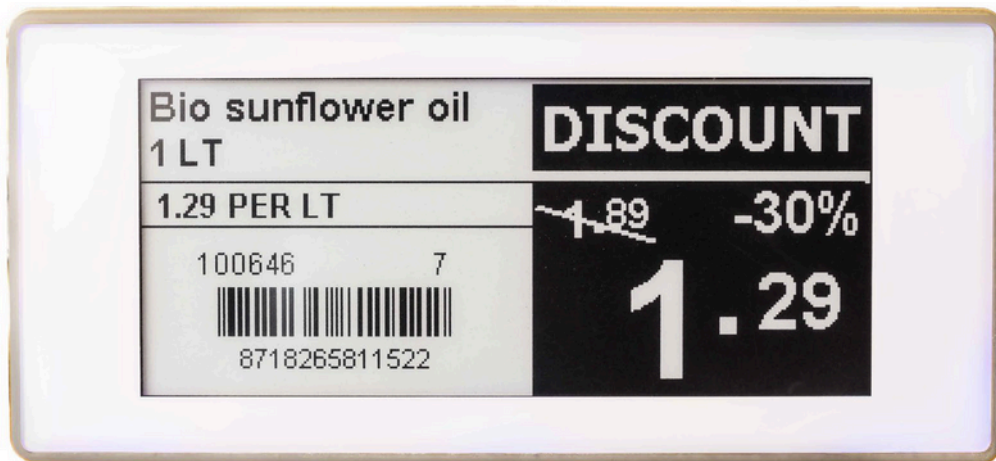

The information in this document is subject to change without notice.

## Document History

Model Number:	EE-293R	Original release date	09-10-2018
Revision: 4	Specification Manual	Date	07-08-2023

## 2018 Copyright Opticon. All rights reserved.

This manual may not, in whole or in part, be copied, photocopied, reproduced, translated or converted to any electronic or machine readable form without prior written consent of Opticon.

## Limited Warranty and Disclaimers

Please read this manual carefully before installing or using the product.

## Serial Number

A serial number appears on all Opticon products. This official registration number is directly related to the device purchased. Do not remove the serial number from your Opticon device. Removing the serial number voids the warranty.

## Warranty

Unless otherwise agreed in a written contract, all Opticon products are warranted against defects in materials and workmanship for two years after purchase excluding batteries. Opticon will repair or, at its option, replace products that are defective in materials or workmanship with proper use during the warranty period. Opticon is not liable for damages caused by modifications made by a customer. In such cases, standard repair charges will apply. If a product is returned under warranty and no defect is found, standard repair charges will apply. Opticon assumes no liability for any direct, indirect, consequential or incidental damages arising out of use or inability to use both the hardware and software, even if Opticon has been informed about the possibility of such damages.

## Packaging

The packing materials are recyclable. We recommend that you save all packing material to use should you need to transport your data collector or send it for service. Damage caused by improper packaging during shipment is not covered by the warranty.

## Trademarks

Trademarks used are the property of their respective owners.

Opticon Inc. and Opticon Sensors Europe B.V. are wholly owned subsidiaries of OPTOELECTRONICS Co., Ltd., 12-17, Tsukagoshi 4-chome, Warabi-shi, Saitama, Japan 335-0002. TEL +81-(0) 48-446-1183; FAX +81-(0) 48-446-1184

## SUPPORT

### USA

Phone: 800-636-0090

Email: [support@opticonusa.com](mailto:support@opticonusa.com)

Web: [www.opticonusa.com](http://www.opticonusa.com)

### Europe

Email: [support@opticon.com](mailto:support@opticon.com)

Web: [www.opticon.com](http://www.opticon.com)

## Revision History

Product Name : EE-293R

Edition	Date	Page	Section	Description of Changes
V0.0	09-10-2018	-	-	Preliminary Version
V1.0	05-04-2019	17~18	10	Updated regulatory information
V2.0	01-11-2021	7	4	Updated operating temperature and humidity
V3.0	20-06-2023	8	5	Internal RAM update
V4.0	07-08	10		Updated radio spec

## Contents

<b>1</b>	<b>Abstract</b> .....	<b>6</b>
<b>2</b>	<b>Overview</b> .....	<b>6</b>
<b>3</b>	<b>Physical Features</b> .....	<b>6</b>
3.1	Dimensions.....	6
3.2	Weight.....	6
<b>4</b>	<b>Environmental Specifications</b> .....	<b>7</b>
4.1	Operating Temperature and Humidity.....	7
4.2	Storage Temperature and Humidity.....	7
4.3	Static Electricity.....	7
<b>5</b>	<b>Controls</b> .....	<b>8</b>
<b>6</b>	<b>Electrical Specifications</b> .....	<b>9</b>
6.1	Electrical Characteristics.....	9
6.2	Battery.....	9
<b>7</b>	<b>Radio Specifications</b> .....	<b>10</b>
7.1	Protocol.....	10
7.1.1	The physical layer.....	10
7.1.2	The medium access control layer.....	10
7.2	Security.....	10
<b>8</b>	<b>Labeling</b> .....	<b>11</b>
8.1	Product Label.....	11
8.2	Shipment Box Label.....	12
<b>9</b>	<b>Packaging Specifications</b> .....	<b>13</b>
9.1	Individual Packaging Specification.....	13
9.2	Collective Packaging Specification.....	13
<b>10</b>	<b>Regulatory Compliance</b> .....	<b>15</b>
10.1	Product Safety.....	15
10.2	EMC.....	15
10.3	WEEE.....	16
10.3.1	Disposal.....	16
10.4	RoHS.....	16
10.5	REACH.....	16
<b>11</b>	<b>Safety</b> .....	<b>17</b>
11.1	Shock.....	17
11.2	Temperature Conditions.....	17
11.3	Foreign Materials.....	17
11.4	Disposal / Battery.....	17
11.5	Other.....	17
<b>12</b>	<b>Mechanical Drawing</b> .....	<b>18</b>

## Table of Figures

Figure 1: Dimensions .....	6
Figure 2: Product Label .....	11
Figure 3: Product Label dimensions .....	11
Figure 4: Shipment box label .....	12
Figure 5: Individual packaging .....	13
Figure 6: collective packaging .....	13
Figure 7: collective shipment packaging .....	14
Figure 8: Mechanical drawing .....	18

## 1 Abstract

This manual provides specifications for the EE-293R Electronic Shelf Label (hereafter referred to as “ESL”).

## 2 Overview

The EE-293R is an electronic shelf label with a black/white/red e-paper display and a 2.4GHz radio for data communication. This product uses Direct Sequence Spread Spectrum RF technology that allows for ultra-low power consumption combined with a reduced sensitivity to background noise. That means less interference by other radios that operate in the 2.4GHz band. The radio protocol that is used is based on the IEEE 802.15.4 standard that specifies the physical layer and media access control for low-rate wireless personal area networks.

A development kit is available that consists out of a base station, several ESL tags and PC software that allows people to quickly test the system and makes it easier to integrate this ESL system into an existing back office system.

## 3 Physical Features

### 3.1 Dimensions

W 92.3 mm x H 42.2 mm x D 11.5 mm

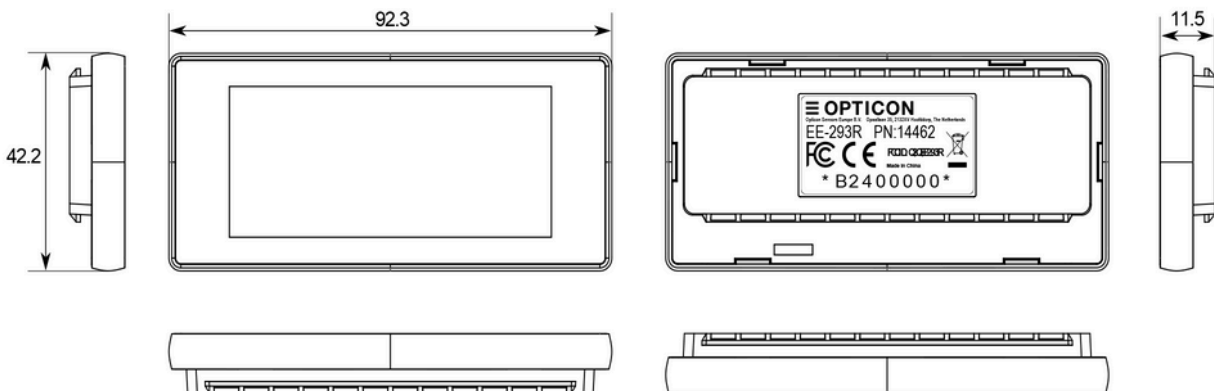

Figure 1: Dimensions

### 3.2 Weight

47.8 g (including batteries)

## 4 Environmental Specifications

### 4.1 Operating Temperature and Humidity

Temperature: 0 to 40° C  
Humidity: 30 to 70% RH (Non-Condensing)

**Warning:** Use the EE-293R under the recommended (green) combinations of temperature and humidity and never use it under the orange marked conditions.

Recommended temp./humidity		Relative Humidity (%)													
		20	25	30	35	40	45	50	55	60	65	70	75	80	
Temp.	0			Green	Green	Green	Green	Green	Green	Green	Green	Green	Green		
	5				Green	Green	Green	Green	Green	Green	Green				
	10					Green	Green	Green	Green	Green	Green				Orange
	15					Green	Green	Green	Green	Green					Orange
	20					Green	Green	Green	Green	Green					Orange
	25	Orange	Orange				Green	Green	Green					Orange	Orange
	30	Orange	Orange	Orange			Green	Green	Green					Orange	Orange
	35	Orange	Orange	Orange	Orange		Green	Green					Orange	Orange	Orange
	40	Orange	Orange	Orange	Orange		Green	Green					Orange	Orange	Orange
	45	Orange	Orange	Orange	Orange								Orange	Orange	Orange
	50	Orange	Orange	Orange	Orange	Orange							Orange	Orange	Orange
	55	Orange	Orange	Orange	Orange	Orange							Orange	Orange	Orange
	60	Orange	Orange	Orange	Orange	Orange					Orange	Orange	Orange	Orange	Orange

### 4.2 Storage Temperature and Humidity

Temperature: -20 to 50° C  
Humidity: 20 to 60% RH (Over full temperature range and Non-Condensing)

### 4.3 Static Electricity

Air discharge:	± 8 kV MAX (No malfunction) ± 15 kV MAX (No destruction)
Contact discharge:	± 4 kV MAX (No malfunction) ± 8 kV MAX (No destruction)



## 5 Controls

Items	Specifications		Remarks
CPU	Type	8051 core 8-bit MCU	
	Internal flash ROM	96KB	
	Internal RAM	6 KB	
	Clock frequency	32 MHz	
Memory	External flash ROM	4Mbit	
LCD	Active area	W 66.90 x H 29.06 mm	
	Number of dots	W 296 x H 128	A dot can become white, black or red
	Dot pitch	112 Horizontal 112 Vertical	Dots per Inch
Radio	Modulation	DSSS	
	Frequency	2405 + 5(C-11) MHz Channel 11-26	Channels 27~28 are available on request. <sup>2</sup>
	Baud rate	250 Kbits / second	

<sup>1</sup>Channels 1~10 are reserved for sub-GHz frequencies, which are not supported by the EBS-50.

<sup>2</sup>Local regulations may not allow the use of these channels.



## 6 Electrical Specifications

### 6.1 Electrical Characteristics

Conditions: Operating voltage 3.0V unless otherwise specified

Parameter		Unit	Remarks
Operating voltage	1.9~3.3	V	Two CR2540 Lithium primary batteries
Sleep current	<1	μA	When the transmitter and receiver are idle
Minimum poll interval	>= 20	seconds	See below

The ESL is in sleep mode almost the entire time. It only wakes up at regular intervals (called the poll time) and then it transmits a poll, which is essentially a request for data, to the base station. When the base station has no data to send it will acknowledge the poll after which the ESL immediately goes back to sleep. The minimum poll rate is configurable and is set to 20 seconds by default. A higher poll interval will decrease the power consumption but will increase the response time.

Even though the minimum poll rate is configurable, the actual poll rate is dynamically increased if necessary. A base station can handle the polls from 25 ESL's per second, so if you have e.g. 1000 ESL's, the minimum poll rate will be increased to 40 seconds.

### 6.2 Battery

The power is supplied to the ESL by 2 CR2450 batteries:

- Nominal capacity: 1200 mAh
- Nominal voltage: 3.0 V.
- Maximum self-discharge rate: <1% per year
- Battery life: 7 years minimum (Update frequency: 4 times per day, poll time 20 seconds). A more detailed set of conditions is listed in the table below.

The battery life is made up of several factors. During transmission e.g., the current consumption is much higher than when the ESL is sleeping. The table below shows the various factors that make up the entire current consumption, plus the conditions under which the lifetime calculation was done.

Factor	Conditions	Correlation *	Influence **
Data communication	Poll interval: 20 seconds Retransmissions: 10% Report ratio: 1 to 39	Yes No Yes	61%
Display updates	4 updates per day Temperature: 15~25° C	No Yes	20%
No connection with base station (Out of range or base station off)	Not connected: 2% Number of channels: 5	No No	4%
Sleep time	99,9%	Yes	9%
Battery self-discharge	1 % / year	No	6%

\* The correlation shows whether increasing the listed value under 'Conditions' increases (Yes) or decreases (No) the battery life of the ESL.

\*\* The influence shows the percentage of the specified factor on the entire current consumption.

For example:

- Increasing the poll interval improves the battery life
- Turning off the base stations shortens the battery life.
- A lower operating temperature (below 15° C) shortens the battery life.
- More display updates per day shortens the battery life.

## 7 Radio Specifications

Parameter	Min	Typ	Max	Unit	Remarks
Receiver sensitivity		-97	-89	dBm	Over the entire temp. and operating voltage range
Nominal output power	0.9		1.1	dBm	
Frequency	2405		2405 + 5(C-11)	MHz	Over the entire temp. and operating voltage range
Transfer rate		250Kbit/s			
RSSI range		100		dB	Signal strength indication that can be reported to the base station

### 7.1 Protocol

Modified 802.15.4 (Physical layer and Media Access Control layer).

#### 7.1.1 The physical layer

The physical layer (PHY) provides the data transmission service, as well as the interface to the physical layer management entity, which offers access to every layer management function and maintains a database of information on related personal area networks. Thus, the PHY manages the physical RF transceiver and performs channel selection and energy and signal management functions. It operates on the above mentioned frequency band. The PHY layer is 100% compliant and is based on direct sequence spread spectrum (DSSS) technique with a transfer rate of 250 kbit/s.

#### 7.1.2 The medium access control layer

The medium access control (MAC) layer enables the transmission of MAC frames through the use of the physical channel. Besides the data service, it offers a management interface and itself manages access to the physical channel. It also controls frame validation, guarantees time slots and handles node associations. Finally, it offers hook points for secure services. The EE-202 does not make use of the optional network beaconing, instead it used a polling mechanism to increase power efficiency. Some changes are made to the standard to allow for more efficient data frames and better power efficiency, especially when nodes are not connected to a base station.

### 7.2 Security

By default only the image transmission is encrypted using a proprietary encryption protocol. Enhanced encryption/authentication can be requested on demand by loading different firmware on the ESLs in combination with the loading of an encryption key and an additional ESL server module. The protection method for RF-communication is done by 128-bit AES encryption.

## 8 Labeling

### 8.1 Product Label

The product label is affixed to the ESL as shown below.



Figure 2: Product Label

**Label material:**

Material: Base + laminate protection against wear.  
 Base: PP film, thickness 80µm, backing with glue.  
 Laminate: PET film, clear, thickness 25µm.  
 RoHS compliant

**Label dimension:**

36 x 19 mm (w x h)  
 Tolerance ± 0.1mm  
 Corner radius 1mm

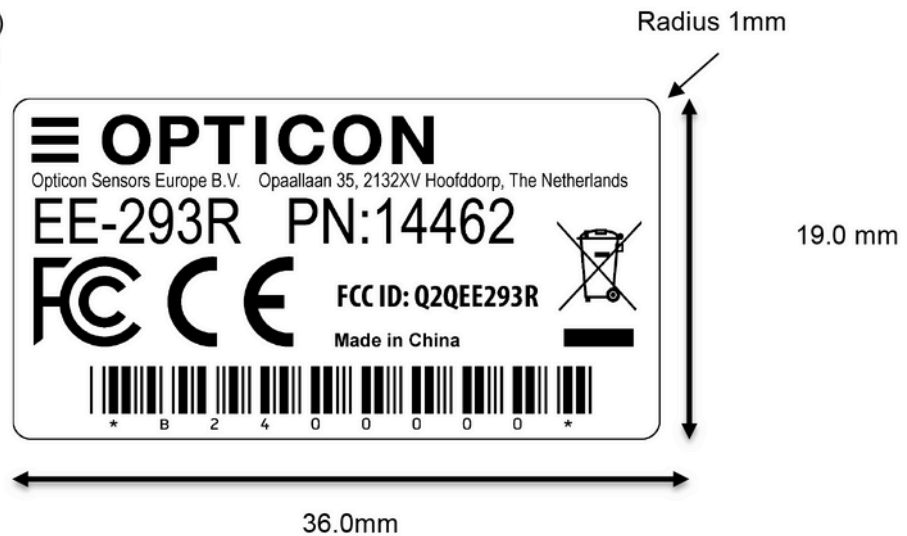

**Barcode area:**

The size of the barcode area (without the human readable part) is 3x38mm).  
 The barcode shows the product serial number. This is a 'B' followed by 10 hexadecimal digits.  
 This serial number is the same as the MAC address in the ESL-label, with the first 6 digits ('3889DC') replaced by a 'B'.

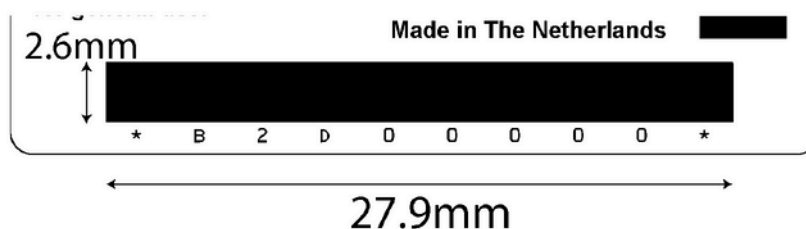

Figure 3: Product Label dimensions

## 8.2 Shipment Box Label

The shipment box labels are meant to show the regulatory information on the shipment box as well as the quantity in the box. The labels are 150mm\*95mm and are made from plain paper with adhesive backing.







<b>≡ OPTICON</b>		C/No XXX Made in China	
Product: EE-293R			
PO:	 * X X X X X - X X *		
Spec#:	 * 0 F 1 E E 2 9 3 R . X X *		
Article code	US:	 * E E 2 9 3 R - 0 0 *	
	EU:	SN (from)	 * 1 4 4 6 2 *      * B 2 4 X X X X X *
QTY:		SN (to)	 * 2 0 0 *      * B 2 4 X X X X X *
Missing Serial Numbers		QTY: 0	
1			
2			
Shipping date: xx-xxxxxxx-20xx			
Software:			
Boot: IAEV0075			
OS: IRVV0075			
AP:			
Opticon Sensors Europe B.V.			

Figure 4: Shipment box label

Note: The “RO” mark labelled on the package tray or package box guarantees that the applicable product has passed our test of RoHS restrictions compliance (the restriction of the use of certain hazardous substances in electrical and electronic equipment, 2002/95 EC). However, this document does not have any legal weight in the European Union.



## 9 Packaging Specifications

### 9.1 Individual Packaging Specification

The ESL's do not need to be packed separately. To easily pack them, 20 pcs need to be packed in a plastic tray:

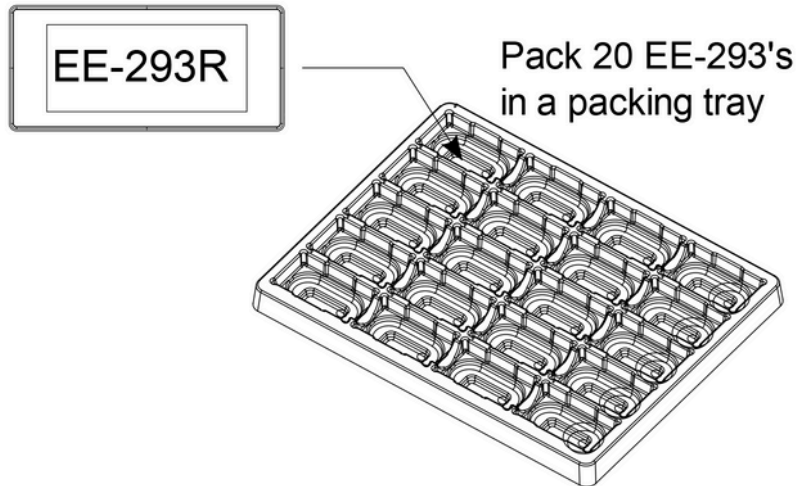

Figure 5: Individual packaging

### 9.2 Collective Packaging Specification

Pack the tray with 20 EE-293R's in a plastic bag, fold the open end of the bag and fix it with a piece of tape.

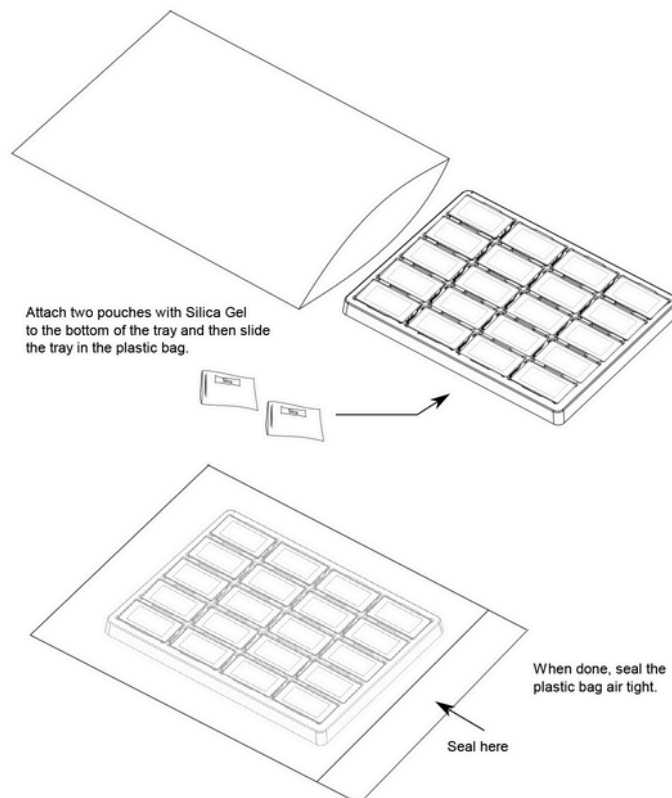

Figure 6: collective packaging

Put 10 stacks, containing 200 ESL's inside a box and stick the shipment box label on the indicated position.

Use cardboard and a plastic bag between each layer of ESL's as shown below.

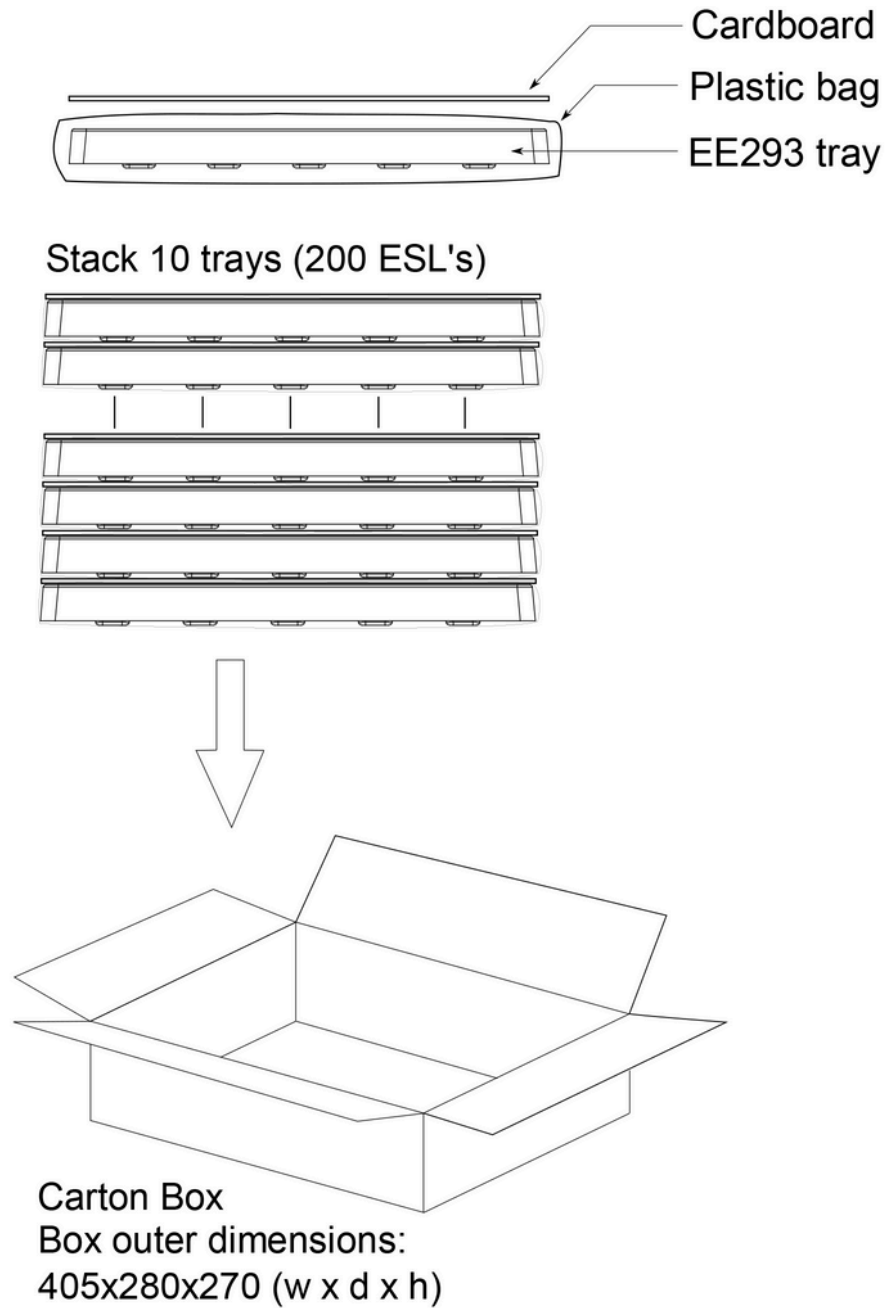

Figure 7: collective shipment packaging

## 10 Regulatory Compliance

Hereby, Opticon Sensors Europe B.V. declares that the radio equipment type EE-293R is in compliance with Directive 2014/53/EU and FCC requirements. The full text of the Declaration of Conformity is available at the following internet address: [www.opticon.com/product/EE-293R](http://www.opticon.com/product/EE-293R)

### 10.1 Product Safety

EN 60950-1:2006+A11:2009+A1:2010+A12:2011+A2:2013  
IEC 60950-1:2005 (2nd Edition)+Am 1:2009+Am 2:2013

### 10.2 EMC

EN55022: 2010  
EN55024: 2010

#### Federal Communications Commission (FCC) Statement

15.21

You are cautioned that changes or modifications not expressly approved by the part responsible for compliance could void the user's authority to operate the equipment.

15.105(b)

This equipment has been tested and found to comply with the limits for a Class B digital device, pursuant to part 15 of the FCC rules. These limits are designed to provide reasonable protection against harmful interference in a residential installation.

This equipment generates uses and can radiate radio frequency energy and, if not installed and used in accordance with the instructions, may cause harmful interference to radio communications. However, there is no guarantee that interference will not occur in a particular installation. If this equipment does cause harmful interference to radio or television reception, which can be determined by turning the equipment off and on, the user is encouraged to try to correct the interference by one or more of the following measures:

- Reorient or relocate the receiving antenna.
- Increase the separation between the equipment and receiver.
- Connect the equipment into an outlet on a circuit different from that to which the receiver is connected.
- Consult the dealer or an experienced radio/TV technician for help.

This device complies with part 15 of the FCC Rules. Operation is subject to the following two conditions:

1. This device may not cause interference and
2. This device must accept any interference, including interference that may cause undesired operation of the device.

#### RF Radiation Exposure Statement:

1. This Transmitter must not be co-located or operating in conjunction with any other antenna or transmitter.
2. This equipment complies with FCC RF radiation exposure limits set forth for an uncontrolled environment. This equipment should be installed and operated with a minimum distance of 20cm between the radiator and your body.



### 10.3 WEEE

Waste Electrical and Electronics Equipment Directive, 2012/19/EU.



#### 10.3.1 Disposal

This appliance is marked according to the European directive 2012/19/EU on Waste Electrical and Electronic Equipment (WEEE). By ensuring this product is disposed of correctly, you will help prevent potential negative consequences for the environment and human health, which could otherwise be caused by inappropriate waste handling of this product.

The above symbol on the product, or on the documents accompanying the product, indicates that this appliance may not be treated as household waste. Instead it shall be handed over to the applicable collection point for the recycling of electrical and electronic equipment. Disposal must be carried out in accordance with local environmental regulations for waste disposal. For more detailed information about treatment, recovery and recycling of this product, please contact your local city office, your household waste disposal service or the dealer where you purchased this product.

### 10.4 RoHS

RoHS: The restriction of the use of certain hazardous substances in electrical and electronic equipment, EU 2015/863.

### 10.5 REACH

Restriction of containing any of the latest REACH Substances of Very High Concern, 1907/2006/EC.

## 11 Safety

Handle this product carefully. Do not deliberately subject it to any of the following.

### 11.1 Shock

- Do not throw or drop the ESL.
- Do not place heavy objects on the ESL.

### 11.2 Temperature Conditions

- Do not use the ESL at temperatures outside the specified range.
- Do not pour boiling water on the ESL.
- Do not throw the ESL into the fire.
- Do not leave the ESL on the dashboard of a car.

### 11.3 Foreign Materials

- Do not immerse the ESL in liquids.
- Do not subject the ESL to chemicals.

### 11.4 Disposal / Battery

Replace the ESL when its lifetime has expired. This is after max. 10 years of operation or sooner when the battery is depleted. When the battery is depleted, discard the complete product with the battery and replace the ESL with a new one. When discarding the product, treat it as chemical waste and dispose of it according to local regulations.

**CAUTION**  
**RISK OF EXPLOSION IF BATTERY IS REPLACED**  
**BY AN INCORRECT TYPE.**  
**DISPOSE OF USED BATTERIES ACCORDING**  
**TO THE INSTRUCTIONS**

### 11.5 Other

- Do not disassemble this product.
- The ESL may be damaged by high voltage discharges.

## 12 Mechanical Drawing

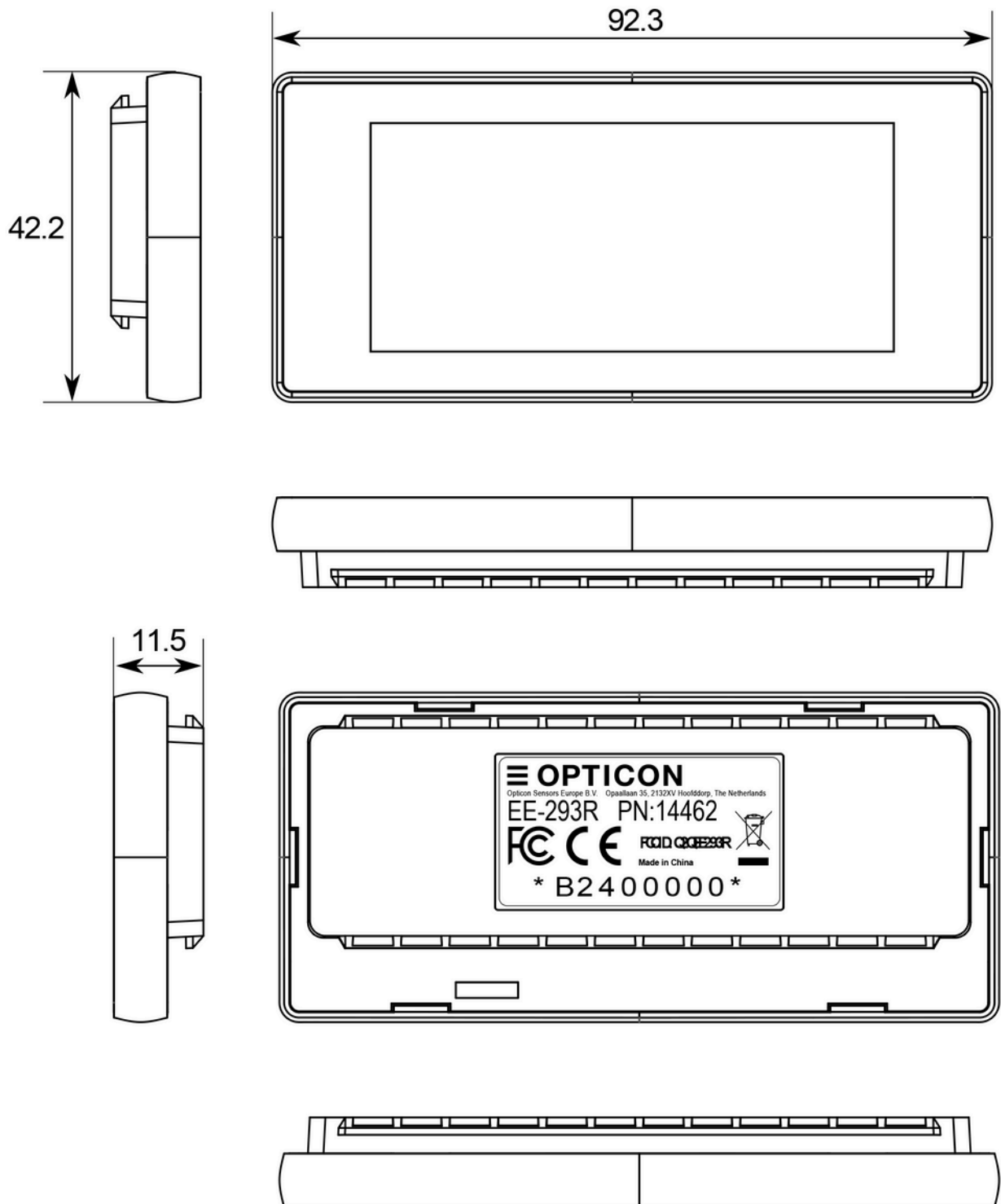

Figure 8: Mechanical drawing