

CN1

Label Printing Scale

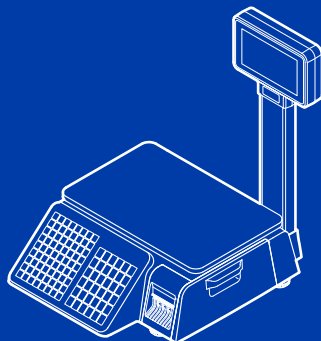

www.globalcas.com

OWNER'S MANUAL

CAS

Thank you for your purchase.

For the proper using & maintaining the scale please read this instruction completely before operating.

Contents

- 1. GENERAL** 10
 - 1.1. Precautions 10
 - 1.2. Introductions 12
 - 1.3. Specifications..... 13
 - 1.4. Name and Functions..... 15
 - 1.5. Symbols..... 17
 - 1.6. Key Functions 18
 - 1.7. Installation of the Label Roll 21

- 2. PROGRAMMING** 23
 - 2.1. PLU Programming 28
 - 2.1.1. Create By-Weight PLU (Menu code 1120)..... 31
 - 2.1.2. Create By-Count PLU (Menu code 1120)..... 37
 - 2.1.3. Create By-PCS PLU (Menu code 1120) 39
 - 2.1.4. Editing PLU (Menu code 1120)..... 41
 - 2.1.5. Management(Menu code 1140) 41
 - 2.1.5.1. Copying PLU (Menu code 1141) 41
 - 2.1.5.2. Deleting PLU (Menu code 1142)..... 42
 - 2.1.5.3. Moving PLU (Menu code 1143)..... 42
 - 2.1.5.4. Selecting PLU field Items (Menu code 1144) 44
 - 2.1.5.5. PLU Sale Count (Menu code 1145)..... 44
 - 2.1.6. Listing PLU (Menu code 1150)..... 45
 - 2.1.7. Sample Printing (Menu code 1170)..... 45
 - 2.2. Programming PLU Data Table I 46
 - 2.2.1. Department (Menu code 1210) 46
 - 2.2.1.1. New/Edit Department (Menu code 1211) 47
 - 2.2.1.2. List Department (Menu code 1212)..... 47
 - 2.2.1.3. Delete Department (Menu code 1213)..... 48
 - 2.2.2. Group (Menu code 1220)..... 48
 - 2.2.2.1. New/Edit Group (Menu code 1221)..... 48
 - 2.2.2.2. List Group (Menu code 1222) 49
 - 2.2.2.3. Delete Group (Menu code 1223)..... 49

2.2.3. Tax Rate (Menu code 1230).....	50
2.2.3.1. New/Edit Tax Rate (Menu code 1231).....	50
2.2.3.2. List Tax Rate (Menu code 1232).....	51
2.2.3.3. Delete Tax Rate (Menu code 1233).....	51
2.2.4. Sales Message (Menu code 1240).....	51
2.2.4.1. New/Edit Sales Message (Menu code 1241).....	52
2.2.4.2. List Sales Message (Menu code 1242).....	53
2.2.4.3. Delete Sales Message (Menu code 1243).....	53
2.2.5. Origin (Menu code 1250).....	54
2.2.5.1. New/Edit Origin (Menu code 1251).....	54
2.2.5.2. List Origin (Menu code 1252).....	55
2.2.5.3. Delete Origin (Menu code 1253).....	55
2.2.6. Barcode (Menu code 1260).....	56
2.2.6.1. New/Edit Barcode (Menu code 1261).....	56
2.2.6.2. List Barcode (Menu code 1262).....	58
2.2.6.3. Delete Barcode (Menu code 1263).....	58
2.2.7. Tare (Menu code 1270).....	59
2.2.7.1. New/Edit Tare (Menu code 1271).....	59
2.2.7.2. List Tare (Menu code 1272).....	60
2.2.7.3. Delete Tare (Menu code 1273).....	61
2.2.7.4. Tare Key (Menu code 1274).....	61
2.2.8. Unit Symbol (Menu code 1280).....	62
2.2.8.1. New/Edit Unit Symbol (Menu code 1281).....	62
2.2.8.2. List Unit Symbol (Menu code 1282).....	63
2.2.8.3. Delete Unit Symbol (Menu code 1283).....	63
2.3. Programming PLU Data Table II.....	64
2.3.1. Ingredient (Menu code 1310).....	64
2.3.1.1. New/Edit Ingredient (Menu code 1311).....	64
2.3.1.2. List Ingredient (Menu code 1312).....	65
2.3.1.3. Delete Ingredient (Menu code 1313).....	65
2.3.2. Nutrition Facts (Menu code 1320).....	66
2.3.2.1. New/Edit Nutrition Facts (Menu code 1321).....	67
2.3.2.2. List Nutrition Facts (Menu code 1322).....	69
2.3.2.3. Delete Nutrition Facts (Menu code 1323).....	69
2.4. Discount Programming.....	70
2.4.1. Discount (Menu code 1130).....	70
2.4.1.1. New/Edit Discount (Menu code 1131).....	70
2.4.1.2. List Discount (Menu code 1132).....	73
2.4.1.3. Delete Discount (Menu code 1133).....	74
2.5. Global Discount Program.....	76
2.5.1. Global Discount (Menu code 1530).....	76
2.5.1.1. Priority Setting (Menu code 1531).....	76
2.5.1.2. Weight/Count/PCS Discount (Menu code 1532/1533/1534).....	77

- 2.6. Speed Key Setting(Menu code 1160) 78
- 2.7. Traceability 79
 - 2.7.1. Traceability (Menu code 1330)..... 79
 - 2.7.1.1. New/Edit Traceability (Menu code 1331)..... 79
 - 2.7.1.2. List Traceability (Menu code 1332) 81
 - 2.7.1.3. Delete Traceability (Menu code 1333)..... 81
- 2.8. County Programming 82
 - 2.8.1. Country (Menu code 1340) 82
 - 2.8.1.1. New/Edit Country (Menu code 1341) 82
 - 2.8.1.2. List Country (Menu code 1342)..... 83
 - 2.8.1.3. Delete Country (Menu code 1343) 83
- 2.9. Programming Slaughter House..... 84
 - 2.9.1. Slaughter House (Menu code 1350)..... 84
 - 2.9.1.1. New/Edit Slaughter House (Menu code 1351) 84
 - 2.9.1.2. List Slaughter House (Menu code 1352) 85
 - 2.9.1.3. Delete Slaughter House (Menu code 1353)..... 85
- 2.10. Programming Cutting Hall 86
 - 2.10.1. Cutting Hall (Menu code 1360)..... 86
 - 2.10.1.1. New/Edit Cutting Hall (Menu code 1361)..... 86
 - 2.10.1.2. List Cutting Hall (Menu code 1362) 87
 - 2.10.1.3. Delete Cutting Hall (Menu code 1363)..... 87
- 2.11. Programming Store Data 88
 - 2.11.1. Store Data (Menu code 1410) 88
 - 2.11.1.1. New/Edit Store (Menu code 1411)..... 88
 - 2.11.1.2. List Store (Menu code 1412) 89
 - 2.11.1.3. Delete Store (Menu code 1413)..... 89
 - 2.11.2. Customer (Menu code 1420)..... 90
 - 2.11.2.1. New/Edit Customer (Menu code 1421) 90
 - 2.11.2.2. List Customer (Menu code 1422)..... 91
 - 2.11.2.3. Delete Customer (Menu code 1423) 91
 - 2.11.3. Currency (Menu code 1440) 92
 - 2.11.3.1. New/Edit Currency (Menu Code 1441)..... 92
 - 2.11.3.2. List Currency (Menu Code 1442) 94
 - 2.11.3.3. Delete Currency (Menu code 1443) 94
 - 2.11.4. Job Batch Schedule (Menu code 1450) 95
 - 2.11.4.1. New/Edit Job Batch Schedule (Menu code 1451) 95
 - 2.11.4.2. List Job Batch Schedule (Menu code 1452) 96
 - 2.11.4.3. Delete Job Batch Schedule (Menu code 1453) 96
 - 2.11.5. Scanner (Menu code 1460) 96
 - 2.11.5.1. New/Edit Scanner Conversion Table (Menu code 1461) 96
 - 2.11.5.2. List Scanner Conversion Table (Menu code 1462) 97
 - 2.11.5.3. Delete Scanner Conversion Table (Menu code 1463) 97
 - 2.11.5.4. Scanner Config (Menu code 1464) 98

2.11.6. Label Format Key Table (Menu code 1470)	99
2.12. Programming Global Setting	100
2.12.1. Global Label Format (Menu code 1510)	100
2.12.2. Barcode Format (Menu code 1520)	102
2.12.3. Tax (Menu code 1540)	105
2.12.3.1. Set Global Tax (Menu code 1541)	105
2.12.3.2. Global Tax Number (Menu code 1542)	105
2.13. Printing Programming (Menu code 1700)	106
2.13.1. Print label item (Menu code 1710)	106
2.13.2. Markdown (Menu code 1720)	108
2.13.3. Printer Hardware (Menu code 1730)	109
2.13.3.1. Print Mode (Menu code 1731)	110
2.13.3.2. Label Size/Ticket Size (Menu code 1732)	110
2.13.3.3. Sensor Calibration (Menu code 1733)	110
2.13.3.4. Sensor & Motor (Menu code 1734)	111
2.13.3.5. Print Intensity (Menu code 1735)	111
2.13.3.6. Adjust Feed Length (Menu code 1736)	111
2.13.3.7. Label Preprint (Menu code 1737)	112
2.13.3.8. Adjust Reverse Feed Length (Menu code 1738)	112
2.13.4. Serial Number Format (Menu code 1740)	113
2.13.5. Add-Up Total (Menu code 1750)	114
2.13.6. Ticket (Menu code 1760)	115
2.13.6.1. Select Ticket Item (Menu code 1761)	115
2.13.6.2. Select List Item (Menu code 1762)	115
2.13.6.3. Select Ticket Font Size (Menu code 1763)	118
2.14. Programming Scale Configuration (Menu code 1800)	119
2.14.1. Sale Mode (Menu code 1810)	119
2.14.2. Operation Mode (Menu code 1820)	121
2.14.3. Department & Store ID (Menu code 1830)	122
2.14.4. Date & Time (Menu code 1840)	122
2.14.5. User/ Security Configuration (Menu code 1850)	123
2.14.5.1. New/Edit User (Menu code 1851)	123
2.14.5.2. Change Password (Menu code 1852)	125
2.14.5.3. List User (Menu code 1853)	125
2.14.5.4. Delete User (Menu code 1854)	126
2.14.5.5. Config Permission (Menu code 1855)	126
2.14.5.6. Clerk Key (Menu code 1856)	127
2.14.6. Test (Menu code 1860)	128
2.14.6.1. Display Test (Menu code 1861)	128
2.14.6.2. A/D Test (Menu code 1862)	128
2.14.6.3. Keyboard Test (Menu code 1863)	129
2.14.6.4. Chess Printer Test (Menu code 1864)	129
2.14.6.5. Printer Sensor Test (Menu code 1865)	129

2.14.6.6. Memory Information (Menu code 1866).....	130
2.14.6.7. Firmware Version (Menu code 1867).....	130
2.14.6.8 Communication (Menu code 1868).....	130
2.14.7. Scale Parameter (Menu code 1870).....	131
2.14.7.1 Backup to USB Memory (Menu code 1877).....	133
2.14.7.2 Restore from USB Memory (Menu code 1878).....	133
2.14.7.3 Scale Info (Menu code 1879).....	133
2.14.8. Function Key Define (Menu code 1880).....	135
2.14.8.1 Function Key Define (Menu code 1881).....	135
2.14.8.2 Function Key Block (Menu code 1882).....	139
2.15. Report.....	140
2.15.1. Introduction.....	140
2.15.2. Report Menu (Menu code 1600).....	140
2.15.3. X1/X2 Report (Menu code 1610/1630).....	141
2.15.4. X1/X2 Scale Sales Report (Menu code 1611/1613).....	141
2.15.5. X1/X2 PLU Report (Menu code 1612/1632).....	143
2.15.6. X1/X2 Miscellaneous PLU Report (Menu code 1613/1633).....	145
2.15.7. X1/X2 Group Report (Menu code 1614/1644).....	147
2.15.8. X1/X2 Department Sales Report (Menu code 1615/1635).....	149
2.15.9. X1/X2 Hourly Sales Report (Menu code 1616/1636).....	151
2.15.10. X1/X2 Clerk Sales Report (Menu code 1617/1637).....	153
2.15.11. Z1/Z2 Report (Menu code 1620/1640).....	155
2.15.12. Clear All Report (Menu code 1650).....	156
3. SALES OPERATION.....	157
3.1. Basic Operation.....	157
3.2. Zero.....	158
3.3. Tare.....	159
3.3.1 Manual Tare Entry 1.....	159
3.3.2 Weighed Tare Entry.....	159
3.3.3 How to Clear Tare.....	160
3.3.4 Preset Tare.....	160
3.4. Calling Up a PLU.....	161
3.4.1 Using Numeric Key.....	161
3.4.2 Using Speed Key.....	161
3.5. Override(FOR key).....	162
3.5.1 By-Weight PLU.....	162
3.5.2 By-Count PLU.....	163
3.5.3 By-PCS PLU.....	164
3.6. Sales Operation.....	166
3.6.1 Weighed Item Operation.....	166
3.6.2 By Count Item.....	167
3.6.3 By PCS Item.....	168

3.7. Discount	169
3.7.1 Unit Price Discount - By Weight PLU.....	169
3.7.2 % Unit Price Discount - By Weight PLU.....	170
3.7.3 Unit Price Discount - By PCS PLU	172
3.8. Add-Up Transaction	173
3.9. Clerk Operation	175
3.9.1 Standard Clerk Operation.....	176
3.9.2 Floating Clerk Operations.....	177
3.10. Void	179
3.11. Payment & Change.....	180
3.12. Return.....	182
3.13. Prepack Key.....	183
3.14. X Key	185
3.14.1 By-Weight PLU	185
3.14.2 Non-Weighed PLU.....	186
3.15. How to Change Sell By Date/Time	187
3.16. How to Change Origin	188
3.17. How to Change PLU Type	189
3.18. Direct Discount.....	190
3.18.1. Fixed Price Key	190
3.18.2. % Discount Price Key.....	191
3.19. PLU Connection	192
3.19.1. Referenced PLU Function.....	192
3.19.2. Coupled PLU Function	192
3.19.3. Link PLU Function.....	192
3.20. Sales Operation Control Parameters	193
3.20.1. Fixed Weight	193
3.20.2. Prepack Without Report.....	193

APPENDIX..... 194

- 1. Label Format 194
 - 1.1. Fixed Label Format Sample..... 195
 - 1.2. Label Format's field Sample..... 202
- 2. ASCII Code Table..... 203
- 3. Window Character Set Information 204
- 4. Error Message..... 205

1. GENERAL

1.1 PRECAUTIONS



Warning

Precautions when installing the scale. To ensure that you get the most from your scale, please follow these instruction.

	<p>Do not disassemble the scale.</p> <p>When any damage or defect occurs, contact your CAS authorized dealer immediately for proper repair.</p>
	<p>Do not overload beyond the maximum weight limit.</p>
	<p>Scale must be grounded to minimize electricity static.</p> <p>This will minimize defect or electric shock.</p>
	<p>Do not pull the plug by its cord when unplugging.</p> <p>Damaged cord could cause electric shock or fire.</p>
	<p>To prevent from fire occurring, Do not place or use the scale near flammable or corrosive gas.</p>
	<p>To reduce electric shock or incorrect reading, Do not spill water on the scale or place it in humid condition.</p>
	<p>Avoid placing the scale near heater or in direct sunlight.</p>
	<p>Insert plug firmly to wall outlet to prevent electric shock.</p>



Attention

Make sure to plug your scale into the proper power outlet.

For maximum performance, plug into a power outlet 30 minutes before the usage for warm up.

	<p>For consistent and accurate reading, maintain periodical check by your CAS authorized dealer.</p>
	<p>Avoid sudden shock to the scale.</p>
	<p>Grab on the bottom of the scale when moving.</p>
	<p>Keep the scale away from other electromagnetic enerating devices. This may interfere with accurate reading.</p>
	<p>Place the scale on firm and temperature consistent environment.</p>
	<p>By adjusting 4 comers of the scale, set the scale even using the built in scale leveling indicator.</p>

• CE Mark Warning

This is a Class A product. In a domestic environment this product may cause radio interference in which case the user may be required to take adequate measures.

1.2 INTRODUCTIONS

Thank you for purchasing the CAS CN1 series price computing electronic printing scale. We have designed this equipment with many advanced features, high quality construction, and user-friendly menu driven programming. We are confident that you will find the CAS CN1 series scale will meet all of your most demanding needs.

Remember, for proper installation and maintenance please have your Authorized CAS Dealer do the primary installation, programming, and demonstration. Your CAS Authorized Dealer also has a wide variety of supplies, accessories, and expansion options for whatever your new and increasing demands may require. Authorized CAS dealers are trained to help you with every aspect of the CN1 series and should you need servicing, they are expertly trained by CAS to assist you with virtually any problem.

1.3 SPECIFICATIONS

Max. Capacity	6/15 kg	15/30 kg	15/30 lb	30/60 lb
Interval	2/5 g	5/10 g	0.005 lb/ 0.01 lb	0.01 lb/ 0.02 lb
Max. Tare	-5.998 kg	-9.995 kg	-9.995 lb	-29.99 lb
A/D Conversion Rate	Approx. 8 times / s			
Measurement Type	Load cell			
Platter Size	380 x 250 mm			

Key	72 PLU key, 36 function key
Speed Key	144 PLU
Display	LCD Preset Tare : 4 digit Weight : 5 digit Unit Price : 6 digit Total Price : 7 digit

Printer	Speed 100 mm/sec
Printing Resolution	202 dpi
Label Size	Width: 40mm~60 mm Length: 30mm~290 mm
Barcode Type	UPC, EAN13, EAN13A5, I2OF5, CODE128, CODE39, CODE93, CODABAR, EAN8, UPCA, UPC-13 , QRcode(option), GS1 DataBar(option)
Font	Small, Middle, Large Size, Free Format, Italic, Bold, Underline, Through Line, Double through line, Reverse, shadow, outline
Printer Type	DIRECT THERMAL PRINT

Operating Temp.	-10°C ~ 40°C (14°F ~ 104°F)
Power	AC 100-240V~ 50/60Hz 1.5A

Programmable Data		Number	Range
	PLU (Price Look Up, Item Index Number)	10000	1~999999
	Ingredient 510 character	1000	1~1000
	User Defined Barcode Format	99	1~99
	Department	99	1~99
	Tax Type	9	1~9
	Group	99	1~99
	Clerk	95	1~95
	Discount	99	1~99
	Origin	500	1~500
	Traceability	999	1~999
	Slaughter House	999	1~999
	Cutting Hall	999	1~999
	Traceability Country	999	1~999
	Label Format	45	Fixed
		20	Free Format
	Bitmap Image	14	0~14
	Customer	89	1~89
	Quantity symbol	8	1~8
	Scroll Message	9	1~9
X1,X2,Z1,Z2 Report			
Pay Type	9		
Sales Message	99	1~99	
Nutrifact	500	1~500	
Tare Table	99	1~99	

Sales Period	Dual totals for daily/monthly or user selectable reporting period.
Sales Report Mode	Read : X1/X2 Mode, Read & Reset: Z1/Z2 Mode

**Note: Specifications are subject to change without notice.
We always call PLUs instead of Item Index Numbers.**

1.4 NAME AND FUNCTIONS

OVERALL VIEW

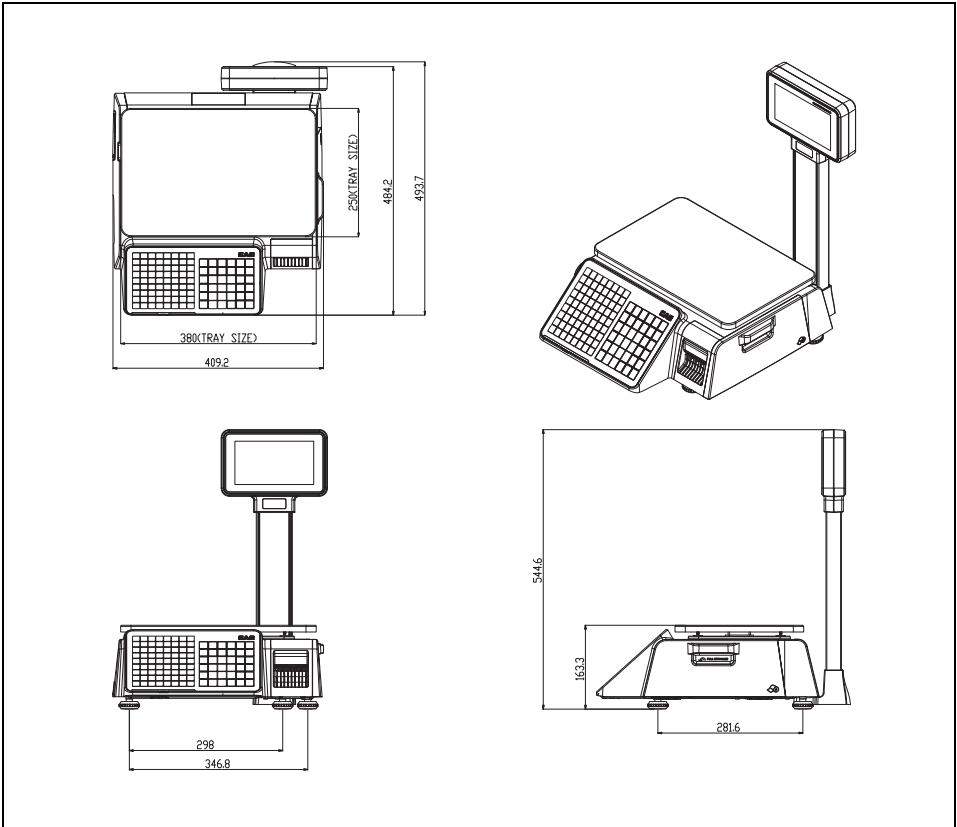



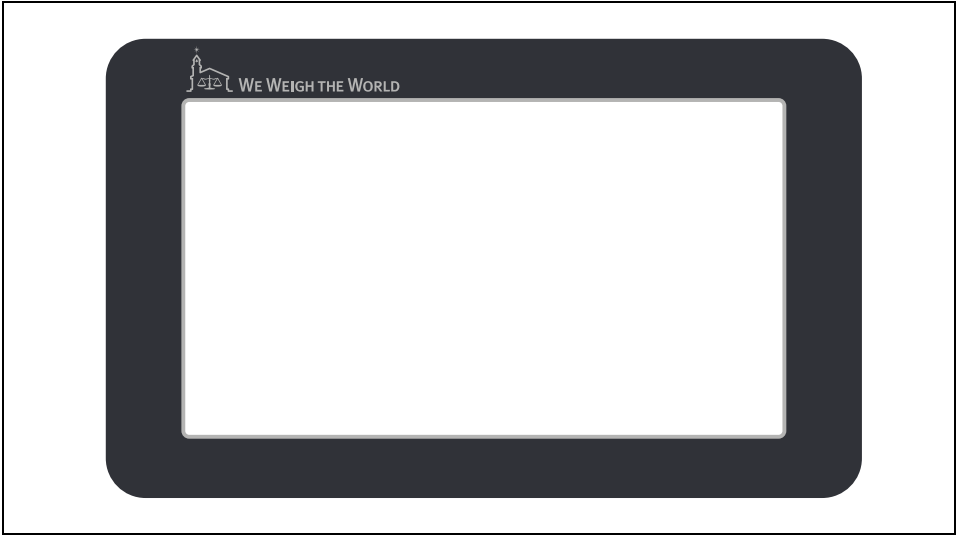

DISPLAY

















KEYBOARD











1.5 SYMBOLS







SYMBOLS	DESCRIPTION
	Stable weight indicator
	Zero weight indicator
	Net weight indicator
AUTO	Print Mode indicator
SAVE	Auto clearing status indicator
PREPACK	Auto clearing status and Print mode indicator
D/C	Discount status indicator
	Speed key shift status indicator
TR	Data transmission status indicator
MASTER	Master status indicator
SLAVE	Slave status indicator
	Ethernet Connection Status

1.6 KEY FUNCTIONS

KEY	FUNCTION
	Numeric keys. Used to enter pricing, qty, count, tare, etc.
	Double zero key.
	Clear key. Used to clear erroneous entries and error conditions.
	Re-Zero key. Use to remove small variations in the scale's zero.
	Tare key. Use to manually enter and remove tare weights.
	Override key. For temporary price change entry.
	Date & Time key. Toggles the display between time, date, scale number and department number. Up arrow key: Used to go to previous line in program mode.
	MENU key. This key toggles from program menu to sale mode. Page up key: Used to go to previous page in program mode.
	For key. Use this key for by- count or by pcs pricing: 3 @ 3 FOR \$1.00. It toggles between the QTY, PIECE, and PRICE fields.
	AUTO key. Auto-print mode
	Pre-Pack key. Used to enter Pre-Packaging mode in which the scale Auto-prints for every transaction and prevents the auto clearing of data. Left arrow key: Used to go to left character in program mode.
	Save key. Save mode prevents the auto clearing of any called-up data like tare weight, PLU pricing, etc.
	Void key. To remove erroneous sales from ADD-Up Right arrow key: Used to go to right character in program mode.
	When you type a PLU number and press this key, it calls-up that PLU. Down arrow key: Used to go to next line in program mode.

KEY	FUNCTION
	<p>ADD-Up key. This key when used in conjunction with ST/TTL key allows you print a customer-total label as well as individual transaction labels. Page down key: Used to go to next page in program mode.</p>
	<p>Multi-Label key. Use this key to print multiple sales of the same transaction. Escape key. It is used to exit in program mode.</p>
	<p>Subtotal / Total key. Used with the ADD key in order to print customer totals.</p>
	<p>Feed key. Use this key to feed labels or paper through printer</p>
	<p>Pay key. Use this key to calculate change. Test key. Used to print test pattern</p>
	<p>Print key. Used to manually print transactions and also serves as an ENTER key in programming mode. There are 2 of them and they both act the same.</p>
	<p>Return key. Used to credit sales for erroneous transactions or returned items. Shift Key. Used to access the second level of Speed Keys in Sales Mode. Used to toggle between Upper Case and Lower Case Alpha Characters.</p>
	<p>Miscellaneous Weighed PLU key.</p>
	<p>Miscellaneous By-Count PLU key.</p>

KEYBOARD

KEY	DESCRIPTION
	Alpha keys. Used to type text data.
	Used to type \$
	Backspace key. Used to backspace and delete text data.
	Space bar.
	Used to go to next line to enter text
	Special symbol keys.
	Used to type special symbol. (See ASCII code table)

Note: X key is only used in sale mode and ESC key is only used in program mode.

Sale mode : X key

Program mode : ESC key



1.7 Installation of the Label Roll

● Label Specifications

Outer diameter of roll : 100mm

Inner diameter of roll : 40mm

Width of receipt roll : 40, 50, 60mm

Width of label roll : 60mm(MAX)

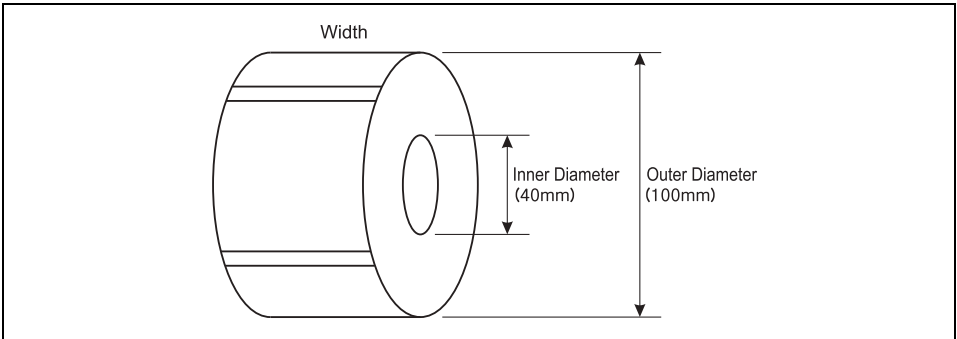

● Print Area

Width of label : 60mm(MAX)

Printable width : 56mm(MAX)

Length of label : 290mm(MAX)

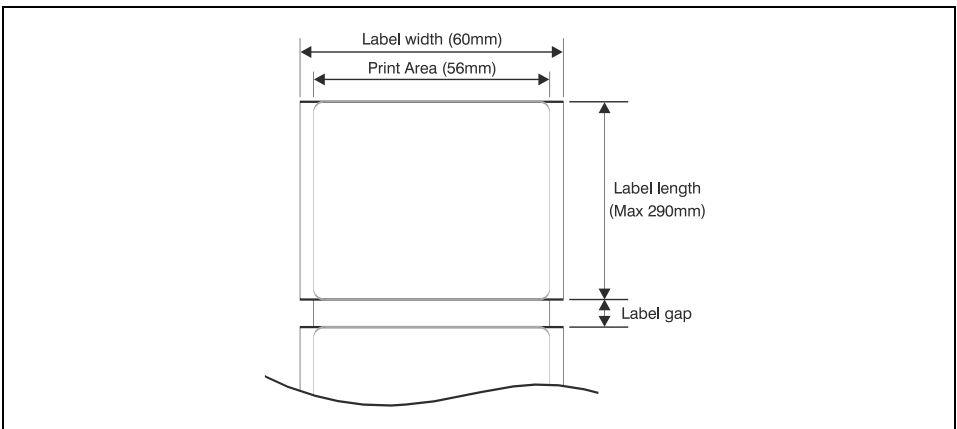

To install the label roll at ANY time you must follow the directions in this section:

- ① Turn lever to open position.

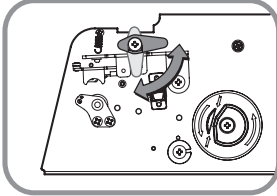

- ② Insert the Roll Paper.

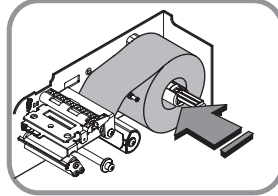

- ③ Upload a Paper Locker.

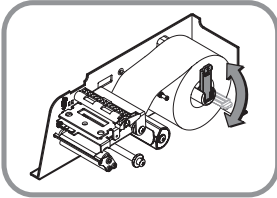

- ④ Place the Paper Between the sensor.

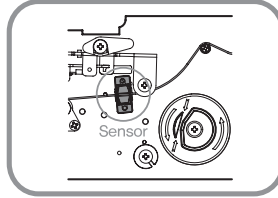

- ⑤ Spool the Paper to unwind and repeat several times.

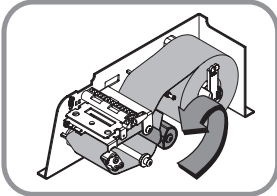

- ⑥ Turn lever to close position.

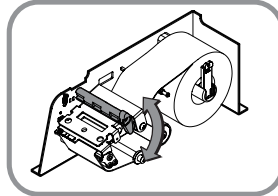

- ⑦ Press the FEED key. Scale prints twice for auto Label adjustment

2. PROGRAMMING

Program Mode Menu Tree (Menu code : 1000)

CODE	Menu	CODE	Sub Menu	CODE	Sub Menu				
1100	PLU	1110	Change unit price						
		1120	New/Edit						
		1130	Discount	1131	New/Edit Discount				
				1132	List Discount				
				1133	Delete Discount	1137	Delete by PLU(DC)		
						1138	Delete by Dept(DC)		
		1139	Delete All(DC)						
		1140	Management	1141	Copy				
				1142	Delete	1147	Delete by PLU No		
						1148	Delete by Dept. No		
						1149	Delete All		
				1143	Move				
				1144	Select PLU Items				
1145	PLU Sale Count								
1150	List								
1160	Speed Key								
1170	Sample Printing								
1200	PLU Data Table I	1210	Department	1211	New/Edit department				
				1212	List department				
				1213	Delete department				
		1220	Group	1221	New/Edit group				
				1222	List group				
				1223	Delete group				
		1230	Tax Rate	1231	New/Edit TAX rate				
				1232	List TAX rate				
				1233	Delete TAX rate				
		1240	Sales Message	1241	New/Edit Sales Message				
				1242	List Sales Message				
				1243	Delete Sales Message				
		1250	Origin	1251	New/Edit Origin				
				1252	List Origin				
				1253	Delete Origin				
		1260	Barcode	1261	New/Edit barcode				
				1262	List barcode				
				1263	Delete barcode				
1270	Tare	1271	New/Edit Tare						
		1272	List Tare						
		1273	Delete Tare						
		1274	Tare Key						

CODE	Menu	CODE	Sub Menu	CODE	Sub Menu	
1200	PLU Data Table I	1280	Unit Symbol	1281	New/Edit Unit Symbol	
				1282	List Unit Symbol	
				1283	Delete Unit Symbol	
1300	PLU Data Table II	1310	Ingredient	1311	New/Edit Ingredient	
				1312	List Ingredient	
				1313	Delete Ingredient	
		1320	Nutrition Facts	1321	New/Edit Nutrition Facts	
				1322	List Nutrition Facts	
				1323	Delete Nutrition Facts	
		1330	Traceability	1331	New/Edit Traceability	
				1332	List Traceability	
				1333	Delete Traceability	
		1340	Country	1341	New/Edit Country	
				1342	List Country	
				1343	Delete Country	
		1350	Slaughter House	1351	New/Edit Slaughter House	
				1352	List Slaughter House	
				1353	Delete Slaughter House	
		1360	Cutting Hall	1361	New/Edit Cutting Hall	
				1362	List Cutting Hall	
				1363	Delete Cutting Hall	
1400	Store data table	1410	Store	1411	New/Edit Store	
				1412	List Store	
				1413	Delete Store	
		1420	Customer	1421	New/Edit Customer	
				1422	List Customer	
				1423	Delete Customer	
		1430	Scroll Message	1431	Configuration	
				1432	Edit Scroll Message	
				1433	List Scroll Message	
		1440	Currency	1441	New/Edit Currency	
				1442	List Currency	
				1443	Delete Currency	
		1450	Job Batch Schedule	1451	New/Edit Schedule	
				1452	List Schedule	
				1453	Delete Schedule	
1460	Scanner	1461	New/Edit Conv Table			
		1462	List Conv Table			
		1463	Delete Conv Table			
1470	Label Format Key Table					
1500	Global Setting	1510	Label Format			
		1520	Barcode			
		1530	Discount	1531	Priority Setting	
				1532	Weight Discount	

		1540	Tax	1533	Count Discount
				1534	PCS Discount
				1541	Set Global Tax
				1542	Global Tax Number
1600	Report	1610	X1 Report	1611	Scale
				1612	PLU
				1613	Misc. PLU
				1614	Group
				1615	Department
				1616	Hourly
				1617	Clerk
		1620	Z1 Report		
		1630	X2 Report	1631	Scale
				1632	PLU
				1633	Misc. PLU
				1634	Group
				1635	Department
				1636	Hourly
		1637	Clerk		
		1640	Z2 Report		
1650	Clear All				
1660	Non-sending Report				
1700	Printer	1710	Print Label Item		
		1720	Markdown		
		1730	Printer Hardware	1731	Print Mode
				1732	Label/Ticket Size
				1733	Sensor Calibration
				1734	Sensor & Motor
				1735	Print Intensity
				1736	Adjust Feed Length
				1737	Label Preprint
		1738	Adjust Reverse Feed Length		
		1740	Serial Number Format		
		1750	Add-Up Total		
		1760	Ticket	1761	Select Ticket Item
1762	Select List Item				
1763	Select Ticket Font Size				
1800	Scale Config	1810	Sale Mode		
		1820	Operation Mode		
		1830	Department & Store ID		
		1840	Date/Time		

CODE	Menu	CODE	Sub Menu	CODE	Sub Menu
1800	Scale Config	1850	User/ Security Configuration	1851	New/Edit User
				1852	Change Password
				1853	List User
				1854	Delete User
				1855	Config Permission
				1856	Clerk Key
		1860	Test	1861	Display
				1862	A/D
				1863	Keyboard
				1864	Chess Printer
				1865	Printer Sensor
				1866	Memory Information
				1867	Firmware Version
				1868	Communication
		1870	Scale Parameter	1871	Display
				1872	Printing
				1873	Sale setup
				1874	Clerk Logout
				1877	Backup to USB Memory
				1878	Restore from USB Memory
1879	Scale Diagnostics Feature				
1880	Function Define Key	1881	Function Key Define		
		1882	Function Key Block		
1900	Communication	1910	Network Setting	1911	Service Type
				1912	DHCP
				1913	IP
				1914	Remote IP
				1915	RS232C
				1916	WLAN setting
		1920	Application		
		1930	Scale Lock/Unlock		
		1940	Check Scale		
		1950	Backup to Scale		
		1960	Slave Scale	1961	New/Edit Slave Scale
				1962	List Slave Scale
1963	Delete Slave Scale				

You can see the Program Menu screen by pressing the MENU key.

The 2 numbers at top right (1/2) indicate the number of pages or screens. The number to the left of the slash is the current page or screen number and the number to the right of the slash indicates the total number of pages or screens. You can use the PG UP and PG DOWN keys to navigate from page to page, or you can use the Arrow keys to go through each page.

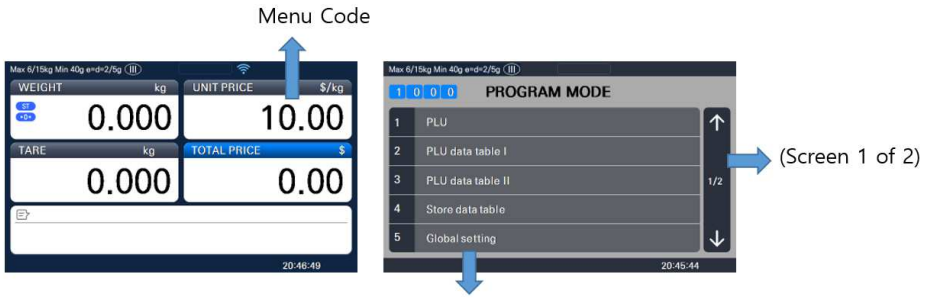

Selectable Menu. If you want to select PLU, simply press 1.

If you press “PG DOWN” key, you can see other menu screens as below.

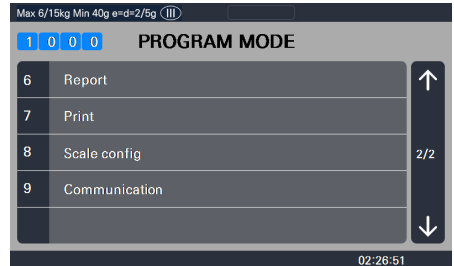
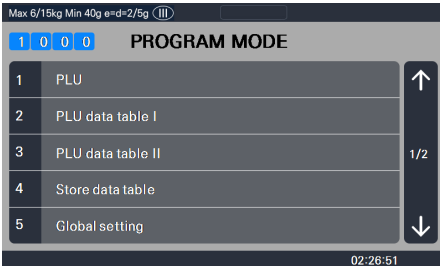

2.1 PLU Programming

You can set 47 items for a PLU as below table and if you do not want to use some items, you can prohibit those items in menu code:1144.

No	Item	Description
1	Department	Department No.
2	PLU No	PLU No.
3	PLU Type	Select PLU type among By Weight, By Count or By-PCS
4	Name	Enter name 1 of item. Maximum 40 characters.
5	Name 2	Enter name 2 of item. Maximum 40 characters.
6	Name 3	Enter name 3 of item. Maximum 40 characters.
7	Group No.	Select group number. This value can be from 0 to 99.
8	Ext.Barcode	13 digits of EAN-13 barcode is used to output them as they are
9	Label No.	(0-99) (0=Do not use Label No.), Label Formats "1-30". If Global Setting is YES, it is not shown.
10	Aux. Label No.	(0-99) (0=Do not use Label No.), Label Formats "1-30". This function prints aux. label as saved number of label number
11	Origin No.	(0-500) 0=Do not use origin.
12	*Fixed Weight	The weight is fixed regardless of item
13	Prefix	Enter serial code for PLU (Greece version of CL5000 series)
14	Item code	Item code
15	Use Fixed Price Type	You can set whether use Fixed Price or not
16	☆Pieces	(0-999) Set the number for By-PCS PLU
17	☆Quantity Unit No.	(0-8) Set symbol of PCS or Count
18	(Unit) Price	This value can be from 0 to 999999.
19	Special Price	It can be unit price by using Special key.
20	Tax No.	Enter tax number. This value can be from 0 to 9
21	*Tare / Tare No.	You can enter tare weight manually or enter No. of tare data. (By-weight PLU)

No	Item	Description
22	* % Tare	0-99.99 You can enter tare weight as percentage of item. If you set it to 20%, 20% of item is tare weight.
23	* Tare % Limit	0-99.99 You can enter tare limit. %tare <= % limit -> Gross weight is printed %tare > % limit -> Net weight is printed
24	Barcode No.	This value can be from 0 to 99, If Global Setting is YES, it is not shown.
25	Barcode2 No.	This value can be from 0 to 99.
26	Picture No.	Image No.
27	Produced Date	(0-999) This is subtracted to the current date in order to be calculated.
28	Packed Date	(0-999) This is added to the current date in order to be calculated.
29	Packed Time	(0-99) If you set it to 0, it is not printed
30	Sell-by Date	(0-9999) This is expirations date that is numbered in days and added to the Packed On date in order to be calculated. If you set it to 0, it is not printed
31	Sell-by Time	(0-99) If you set it to 0, it is not printed
32	Cook-by Date	(0-9999) This is expirations date that is numbered in days and added to the Packed On date in order to be calculated.
33	Ingredients No.	(1~1000) Enter ingredients
34	Traceability No.	(0-99) Enter traceability No.
35	Bonus	For future use.
36	Nutri. Fact No.	(0-500) Enter nutrition fact ID
37	Sales Msg No.	(0-99) Enter sales message No.
38	Reference PLU Dept.	(0-99) Enter reference department No.
39	Reference PLU No.	(0-999999) Enter reference PLU No.
40	Coupled PLU Dept.	(0-99) Enter coupled PLU department
41	Coupled PLU No.	(0-999999) Enter coupled PLU No.
42	# of Link PLU	(0-2) Enter the number of linked PLU.

No	Item	Description
43	★Link PLU1 Dept.	(0~99) Enter PLU1 department No.
44	★Link PLU1 No.	(0~999999) Enter PLU1 No.
45	★Link PLU2 Dept.	(0~99) Enter PLU2 department No.
46	★Link PLU2 No.	(0~999999) Enter PLU2 No.

* These items are shown on the display when you select **By Weight PLU**.

☆ These items are shown on the display when you select **By Count** or **By PCS PLU**.

★ These items are shown on the display when you input # of **Link PLU**.

2.1.1 Create By-Weight PLU (Menu code 1120)

(NEW/Edit PLU : MENU → 1. PLU → 2. New/Edit)

- ◆ You can press the SAVE key at anytime to save the current PLU data and if you want to exit without saving, press the ESC key.

Note: You may experience different item menus and screen numbers. You can modify menu items at menu (1144)

1. Create By-Weight PLU (Menu code 1120)

- Department should be set previously

EX) Department No. = [1] Default
 PLU No. : [1]

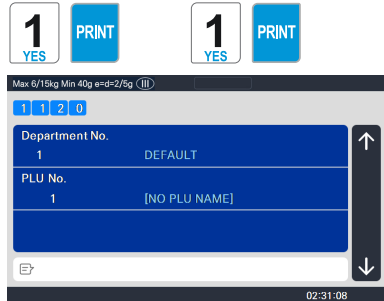

2. Select PLU Type

1. By Weight
2. By Count
3. By PCS

EX) BY-Weight Item

By-Weight PLUs are priced as price-per weight; for example, \$3.99/lb or \$1.99/kg. You must weigh these PLUs before you can execute a sales transaction.



3. Enter PLU Name 1

EX) "BEEF"

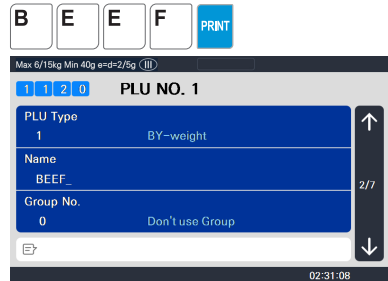

4. Select Group

- You can use Group depending on the Menu code 1220.
- If there is no group for this PLU, enter 0.

EX) 1. Meat

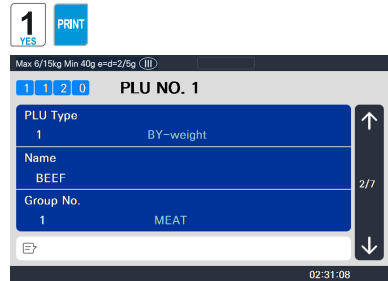

5. Select Origin

- You can use Origin depending on the Menu code 1250.
- If there is no origin for this PLU, enter 0.

EX) 49. China

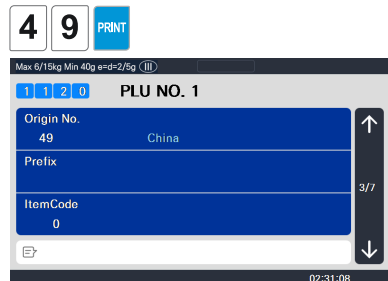

6. Enter Prefix

- If you do not want to use prefix, enter 0.

EX) Do not use prefix



7. Item Code

- If you do not want to use item code, enter 0.

EX) Item Code = 1941



8. Price

EX) Price = \$10.00

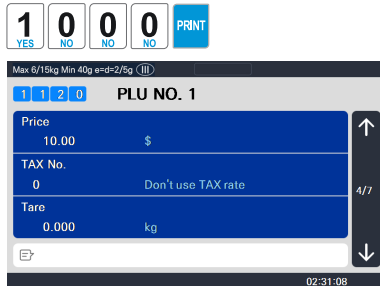

9. Tax No.

- Maybe changed using Menu Code 1231. If the Global Tax Settings (Menu Code 1541) is not used.
- If you do not want to use, enter 0.

EX) Tax No. 1

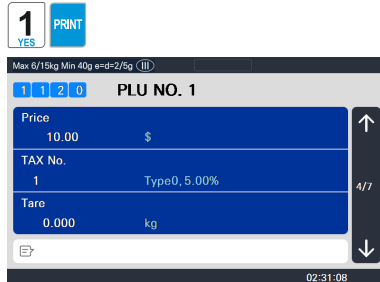

10. Tare

- You can use Tare Table, depending on the setting of Parameter 584. You can set Tare Table(Menu code 1270)

EX) Tare Value = 100g

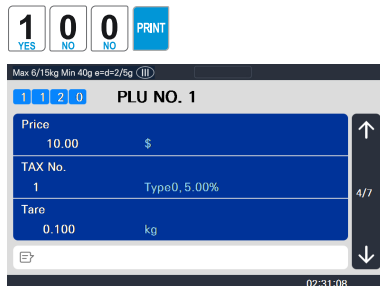

11. Produced Date

- Print Date minus the Input Value in Days.
See chart on next page.

EX) 0 : No print
 1 : Print Date – 1 day
 2 : Print Date – 2 days

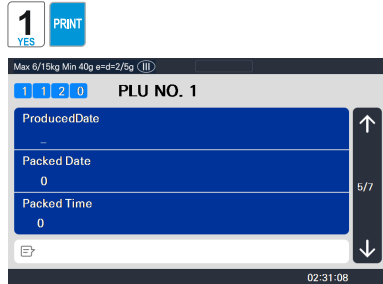

12. Packed Date

- Print Date plus Input Value in Days.
See chart on next page.

EX) 0 : Today
 1 : Today + 1 day
 2 : Today + 2 days

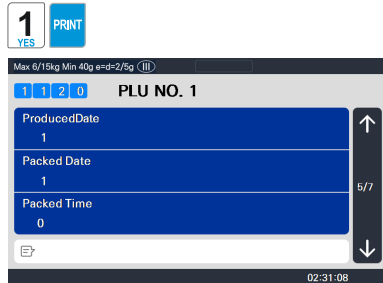

13. Packed Time

- Print Time plus Input Value in Hours.
See chart on next page.

EX) 0 : Hour Printed
 1 : Hour Printed + 1 Hour
 2 : Hour Printed + 2 Hours

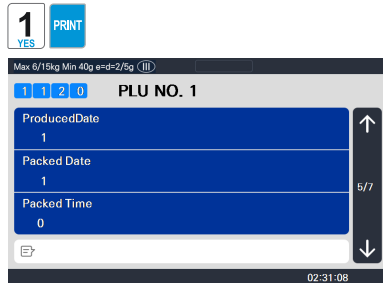

14. Sell By Date

- Packed Date plus Input Value in Days
Minus 1 Day. See Chart on next page.

EX) 1 : Today
 2 : Packed date + 1



15. Sell By Time

- Packed Time plus Input Value in Hours.
See Chart on next page.

EX) 0 : Current Time
1 : Packed Time + 1 Hour

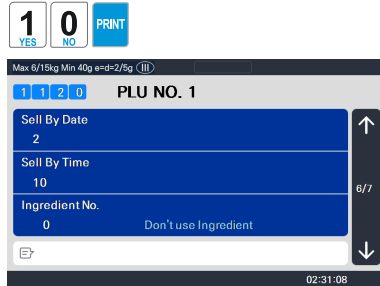

PLU fill in Item	Description	Value				Calculation
		0	1	2	...	
Produced Date	Before Printing Date	No print	Yesterday	Before yesterday	...	Print Date – Input Value(Day)
Packed Date	After Printing Date	Today	Tomorrow	After tomorrow	...	Print Date + Input Value(Day)
Packed Time	After Printing Time	Current	After 1 HR	After 2HR	...	Print Time + Input Value(hour)
Sell by Date	After Packing Date	NO print	Today	Tomorrow	...	Packed Date + Input Value(Day) – 1
Sell by Time	After Packing Time	Current	After 1HR	After 2HR	...	Packed Time + Input Value(hour)
Cook by Date	After Packing Date	NO print	today	tomorrows	...	Packed Date + Input Value(Day) – 1

16. Ingredient No.

- You can use Ingredient depending on the Menu code 1310.
- If there is no ingredient for this, enter 0.

EX) Do not use ingredient

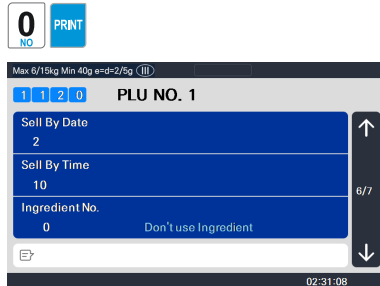

17. Sales Message No.

- If you do not want to use, enter 0
Note : You can preset sales message at menu code(1241)

EX) Sales Message 1



18. Reference PLU Department

- If you do not want to use, enter 0

EX) Reference PLU Department = 0

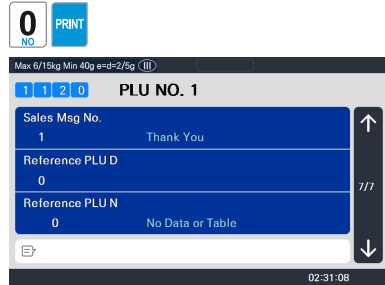

19. Reference PLU No.

- If you do not want to use, enter 0

EX) Reference PLU No. = 0

Usage is possible to register the reference key at 1880 in order to use the No. 36~37 reference PLU.

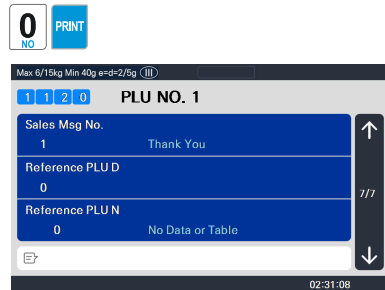

2.1.2 Create By-Count PLU (Menu code 1120)

(MENU → 1. PLU → 2. New/Edit)

※ Showing only the different parts of PLU items

- ◆ You can press the SAVE key at anytime to save the current PLU data and if you want to exit without saving, press the ESC key.

1. Enter Department No. / PLU No.

- Department should be set previously
EX) Department # = 1. Default
PLU # = 2

1
PRINT

2
PRINT

Max 6/15kg Min 40g e=d=2/5g (II)

1	1	2	0
Department No.			
1	DEFAULT		
PLU No.			
2	[NO PLU NAME]		

02:31:08

2. Select PLU Type

1. By Weight
2. By Count
3. By PCS

EX) BY-Count Item

2
PRINT

Max 6/15kg Min 40g e=d=2/5g (II)

1	1	2	0	PLU NO. 2
PLU Type				
2	BY-count			
Name				
2/7				
Group No.				
0	Don't use Group			

02:31:08

3. Enter PLU Name 1

EX) PEAR

P
E
A
R
PRINT

Max 6/15kg Min 40g e=d=2/5g (II)

1	1	2	0	PLU NO. 2
PLU Type				
2	BY-count			
Name				
PEAR				
2/7				
Group No.				
0	Don't use Group			

02:31:08

4. Qty Unit No.

EX) Qty Unit No. 6

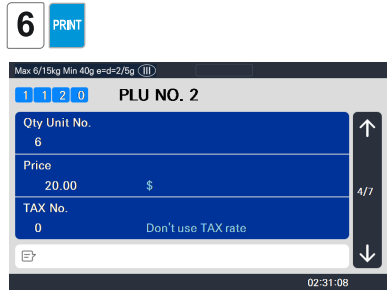

5. Price

EX) Price = \$10.00

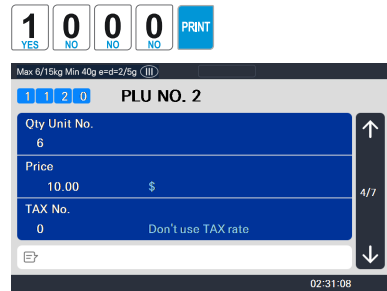

2.1.3 Create By-PCS PLU (Menu code 1120)

(MENU → 1. PLU → 2. New/Edit)

※ Showing only the different parts of PLU field By-PCS PLU is used depending on the Parameter 593.

◆ You can press the SAVE key at anytime to save the current PLU data and if you want to exit without saving, press the ESC key.

1. Enter Department No. / PLU No.

• Department should be set previously.

EX) Department # = 1. Default
 PLU # = 2

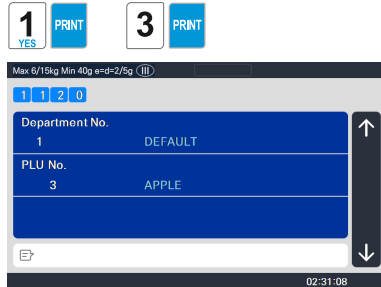

2. Select PLU Type

1. By Weight
2. By Count
3. By PCS

EX) BY-PCS Item

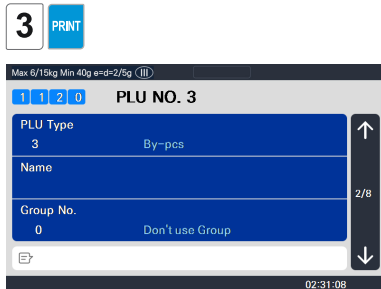

3. Enter PLU Name1

EX) CAKE

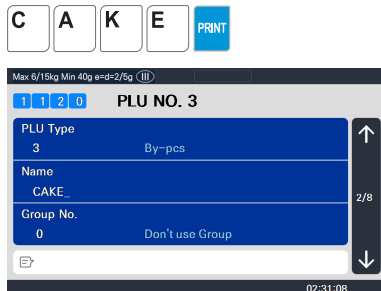

4. Pieces

- If you enter 0, it is regarded as 1.

EX) 10 piece

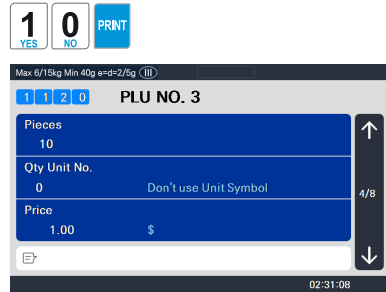

5. Qty Unit No.

EX) Qty Unit No. 6



2.1.4 Editing PLU (Menu code 1120)

(MENU → 1. PLU → 2. New/Edit)

- ◆ You can call up existing PLU information for edit.

2.1.5 Management(Menu code 1140)

2.1.5.1 Copying PLU (Menu code 1141)

(MENU → 1. PLU → 4. Management → 1. Copy)

- If there is a similar PLU, you can copy it.

1. Select Source

- Enter the Department No. and PLU No. that you wish to copy

EX) Source Department # = 1
Source PLU # = 1

Note : If PLU number exists in destination department you will be asked to confirm the copy.

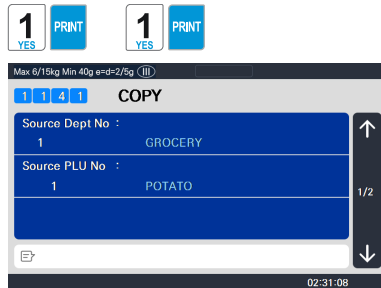

2. Select Destination

- Enter the Department number where the New PLU(s) will be located
- Enter the PLU number that you wish to copy the Source PLU into

EX) Destination Department # = 2
Destination PLU # = 1

Note : If PLU number exists in destination department you will be asked to confirm the move

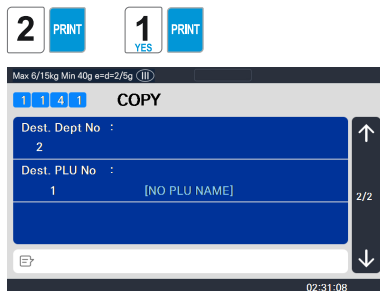

2.1.5.2 Deleting PLU (Menu code 1142)

(MENU → 1. PLU → 4. Management → 2. Delete)

- If There are three ways to delete PLU. Simply enter the number that you wish to delete.

EX) Press 1 key to select Delete by PLU No.



EX) Department No. : 1
PLU No. : 1

Note: There is no confirmation request for deletion. After entering the PLU number and pressing Print, the PLU will be deleted.

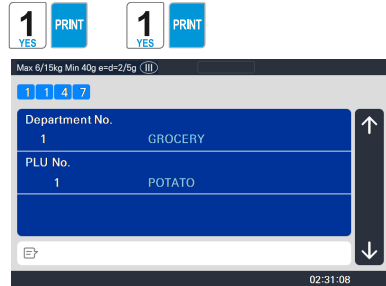

2.1.5.3 Moving PLU (Menu code 1143)

(MENU → 1. PLU → 4. Management → 3. Move)

- All the PLU information will move with commend (discount, Tax, barcode type, etc)

1. Select Source

- Enter the Department No. and PLU No. which you wish to move

EX) Source Department # = 1
Source PLU # = 1

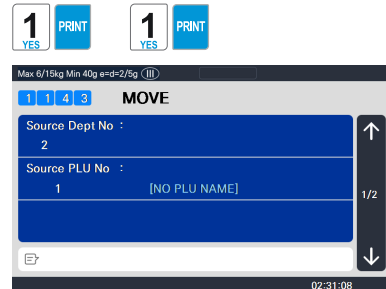

2. Select Destination

- Enter the Department number where the PLU(s) will be located
- Enter the PLU number that you wish to move the Source PLU into

EX) Destination Department # = 2
Destination PLU # = 1

Note : If PLU number exists in destination department you will be asked to confirm the move

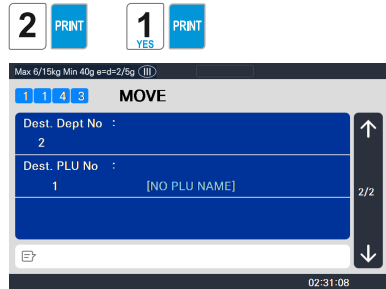

2.1.5.4 Selecting PLU field Items (Menu code 1144)

(MENU → 1. PLU → 4. Management → 4. Select PLU items

- If you enter N, you cannot use that item when you create PLU.

To enter Y, press Y key or 1 key.

To enter N, press N key or 0 key.

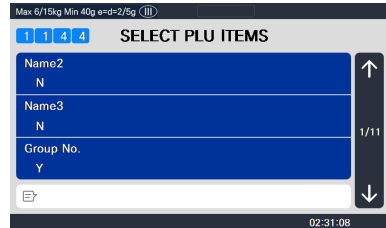

Note: You can use the **PG UP** and **PG DOWN** keys to navigate from page to page, or you can use the Arrow keys to go through each page 1 line at a time. A list of all available PLU Field Items can be found at the beginning of Section 2.1.

2.1.5.5 PLU Sale Count(Menu code 1145)

(MENU → 1. PLU → 4. Management → 5. PLU Sale Count

You can count each PLU sale and also you can clear this count.

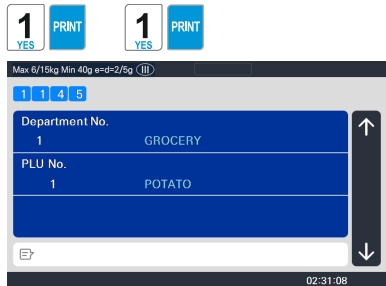

- The Sale Count function is used to keep track of the number of times a label has been issued for a particular PLU without having to use the Report Menu.

- To clear the selected PLU Sale Count, press the TEST key. To clear all PLU Sale Counts press the ZERO key.

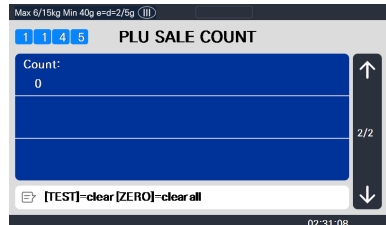

2.1.6 Listing PLU (Menu code 1150)

(MENU → 1. PLU → 5. List)

Note: Finding PLU; You need to know department # and PLU #.

1. Enter Department No.

- Enter department number that you wish to see

EX) Department No. 1



2. Enter PLU Range

EX) PLU 1~10

- Press Print Key to List PLU's on screen.
After PLU's are listed on the screen pressing the TEST key will print the PLU's.

Note: Printing should be done on continuous label stock.

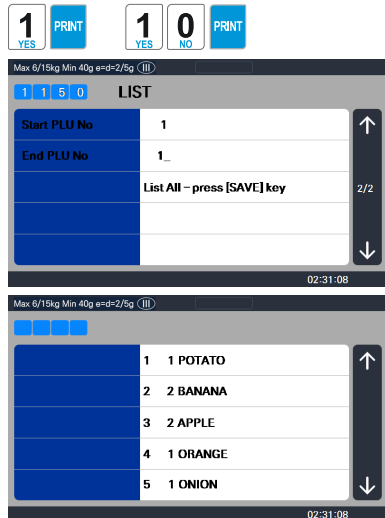

2.1.7 Sample Printing (Menu code 1170)

(MENU → 1. PLU → 7. Sample Printing)

- Used to enable printing a sample PLU label

EX) If set to Yes, when editing an existing PLU or creating a new one, depressing the SAVE key will result in a label being printed with that PLU's information on it.

2.2 Programming PLU Data Table I

In the CL5000 series, PLU's are organized by Departments and sometimes Groups as shown in the figure below. It is important to understand this structure to take advantage of the CL5000 series sophisticated features regarding Label formats, X and Z reports, etc.

Note: Groups can cross-over the hierarchy of the department structure. You can organize PLU's by manufacturer, sales promotions, price range, etc.

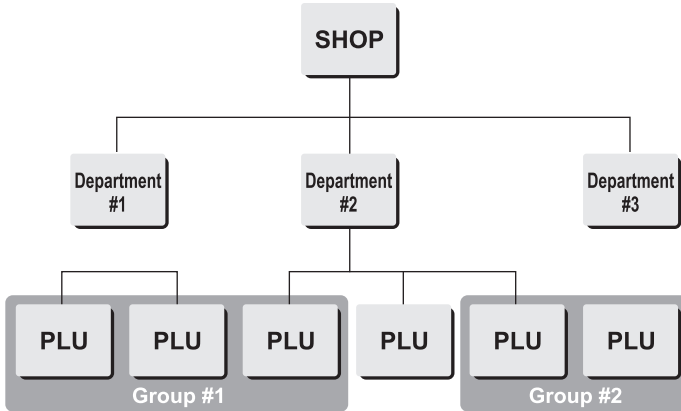

Note: The CL5000 series has a sophisticated discount price programming function. The discount price function can be programmed in great detail. Programming may be done very easily using the PC software program CL-Works.

2.2.1 Department (Menu code 1210)

(MENU → 2. PLU Data Table I → 1. Department)

The CL5000 series can be programmed to have up to 99 different departments with like PLU numbers in each department. The Scale ID setting (Menu 1830) determines which PLU's an operator will be able to access on that scale. The operator will only be able to call up PLU's assigned to the Department Number programmed in the Scale ID setting. The Department number can be changed to access the different departments programmed in the scale. Each Department also has a specific Speed Key Set assigned to it in Menu 1830.

2.2.1.1 New/Edit Department (Menu code 1211)

(MENU → 2. PLU Data Table I → 1. Department → 1. New/Edit)

- ◆ You can press the SAVE key at anytime to save the current data and if you want to exit without saving, press the ESC key.

1. Department Number

- Department number is available 1 to 99.

EX) Department No. = 2



2. Department Description

EX) Department Description = GROCERY

3. Speed Key Setting

- Refer to 2.6 Speed Key

EX) Speed key set no. = 1

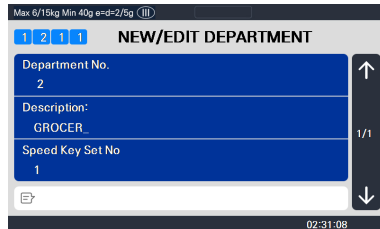

Note: You can select from 5 different Speed Key sets. Refer to Section 2.6 Speed Key Set No.

2.2.1.2 List Department (Menu code 1212)

(MENU → 2. PLU Data Table I → 1. Department → 2. List)

1. Enter the range of Departments wish to see.

EX) Department 1 to 10

- If you want to print list, press the TEST key.
- Press Print Key to List Departments on screen. After Departments are listed on the screen pressing the TEST key will print the Departments.

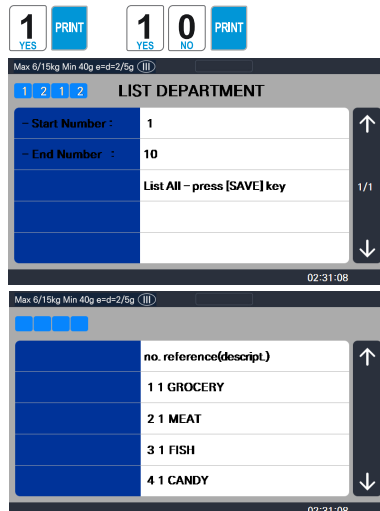

2.2.1.3 Delete Department (Menu code 1213)

(MENU → 2. PLU Data Table I → 1. Department → 3. Delete)

1. Enter Department number

EX) Delete department 2

Note: There is no confirmation request when deleting a Department. Pressing the PRINT key will cause the Department entered to be deleted.

Caution : You can't delete department 1 for keep system's security



2.2.2 Group (Menu code 1220)

(MENU → 2. PLU Data Table I → 2. Group)

The Group menu is used to allow PLU's to be grouped regardless of their Department assignments. A PLU must be assigned to a Department but does not have to be assigned to a Group. The User may assign PLU's to a Group for the purpose of tracking sales promotions, manufacturer's information, price ranges, etc.

2.2.2.1 New/Edit Group (Menu code 1221)

(MENU → 2. PLU Data Table I → 1. Group → 1. New/Edit)

You Can press the SAVE key at anytime to save the current data and if you want to exit without saving, press the ESC Key.

1. Enter Group Number

- Group number is available 1 to 99.

EX) Group No = 1



2. Enter Group Description

EX) Group Description = BAGEL

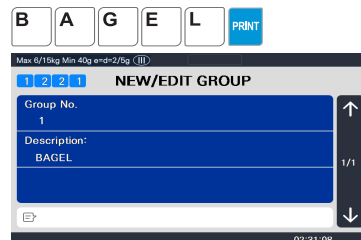

2.2.2.2 List Group (Menu code 1222)

(MENU → 2. PLU Data Table I → 2. Group → 2. List)

1. Set the group range that you wish to see

EX) Groups 1~10

- Press Print Key to List Groups on screen.
After Groups are listed on the screen, pressing the TEST key will print the Groups.



2.2.2.3 Delete Group (Menu code 1223)

(MENU → 2. PLU Data Table I → 2. Group → 3. Delete)

1. Enter group number

EX) Delete group 1.

Note: There is no confirmation request when deleting a Group. Pressing the PRINT key will cause the Group entered to be deleted.

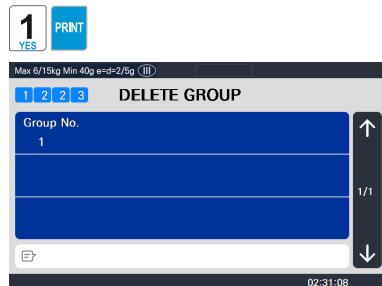

2.2.3 Tax Rate (Menu code 1230)

(MENU → 2. PLU Data Table I → 3. TAX rate)

You can use tax number when you create PLU.

Note: Tax Rate programming requires that a Level 3 Password be entered. See Section 2.14.6 User/Security Configuration.

2.2.3.1 New/Edit Tax Rate (Menu code 1231)

(MENU → 2. PLU Data Table I → 3. TAX Rate → 1. New/Edit)

1. Enter tax number

- TAX number is available 1 to 9
- EX) TAX No. =1



2. Set Tax Type

- See Tax Type table as below.
- EX) Internal TAX Type

3. Enter Tax Rate

EX) Tax Rate = 5.00%

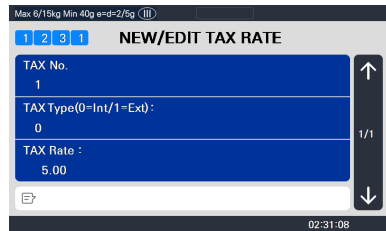

Item	Symbol	Description
Internal TAX	0	Tax is included in total price
External TAX	1	Tax is added on total price

※ Refer to menu code 1873(T.price = price + Tax) on chapter 2.14.7

4. Exit Menu

- If you want to exit, press ESC key.



2.2.3.2 List Tax Rate (Menu code 1232)

(MENU → 2. PLU Data Table I → 3. TAX Rate → 2. List)

1. Set the range of tax rate

EX) 1~9

Press Print Key to List Tax Rates on screen.
After Tax Rates are listed on the screen, pressing the TEST key will print the Tax Rates.

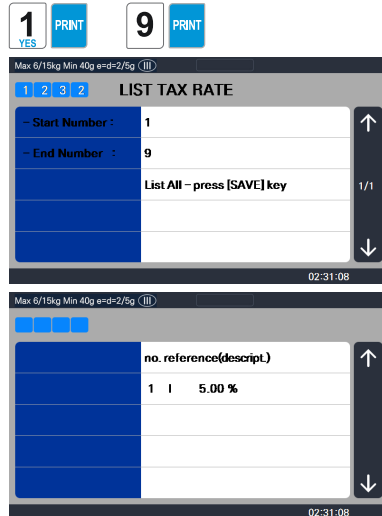

2.2.3.3 Delete Tax Rate (Menu code 1233)

(MENU → 2. PLU Data Table I → 3. TAX Rate → 3. Delete)

1. Enter tax number

EX) Delete tax number 1

Note: There is no confirmation request when deleting a Tax Rate. Pressing the PRINT key will cause the Tax Rate entered to be deleted.

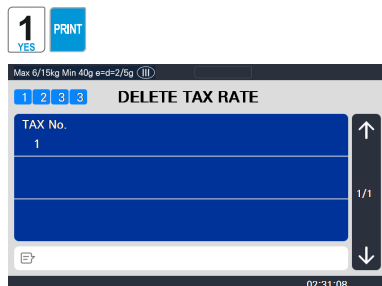

2.2.4 Sales Message (Menu code 1240)

(MENU → 2. PLU Data Table I → 4. Sales Message)

Sales message can be printed on PLU labels so long as the format that you use contains a Sales Message field. This is a great tool for advertising and cross-marketing products.

2.2.4.1 New/Edit Sales Message (Menu code 1241)

(MENU → 2. PLU Data Table I → 4. Sales Message → 1. New/Edit)

You can press the SAVE key at anytime to save the current data and if you want to exit without saving, press the ESC key.

1. Enter Message Number

- Message number is available 1 to 99

EX) Message No. = 1

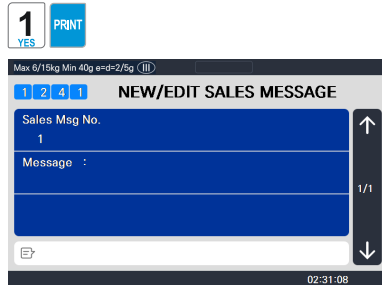

2. Enter Message

EX) Message = THANK YOU

Note: You can use lower case letter and special symbol by pressing shift / ASCII code

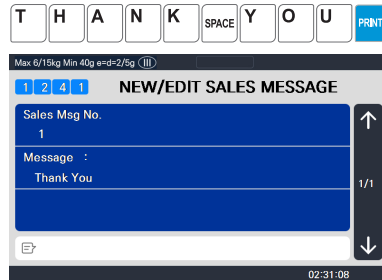

3. Exit Menu

- If you want to exit, press ESC key.



2.2.4.2 List Sales Message (Menu code 1242)

(MENU → 2. PLU Data Table I → 4. Sales Message → 2. List)

1. Set the List Range

- Set the range of sales message that you wish to check

EX) 1-10

- Press Print Key to List Sales Messages on screen. After Sales Messages are listed on the screen, pressing the TEST key will print the Sales Messages.

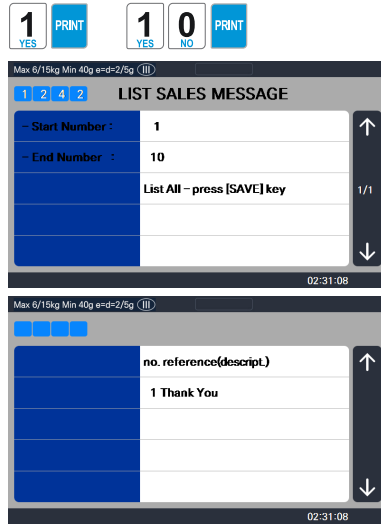

2.2.4.3 Delete Sales Message (Menu code 1243)

(MENU → 2. PLU Data Table I → 4. Sales Message → 3. Delete)

1. Enter Message No.

EX) Delete message 1.

Note: There is no confirmation request when deleting a Sales Message. Pressing the PRINT key will cause the Sales Message entered to be deleted.



2.2.5 Origin (Menu code 1250)

(MENU → 2. PLU Data Table I → 5. Origin)

To print the Country of Origin on a Label, the Label Format being used must contain an Origin Field. You can also print the Country of Origin in one of the Commodity Name Lines by using Menu Code 1872. Again, your Label Format must have an area available to print the Origin.

2.2.5.1 New/Edit Origin (Menu code 1251)

(MENU → 2. PLU Data Table I → 5. Origin → 1. New/Edit)

※ You can press the SAVE key at anytime to save the current data and if you want to exit without saving, press the ESC key.

1. Enter Origin No.

- Origin number is available 1 to 500 +

EX) Origin No = 10

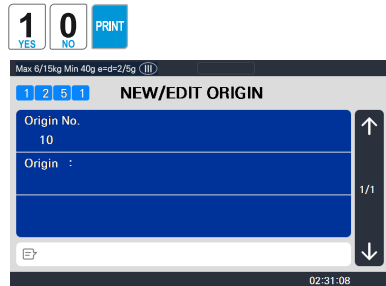

2. Enter Origin

EX) Origin = KOREA

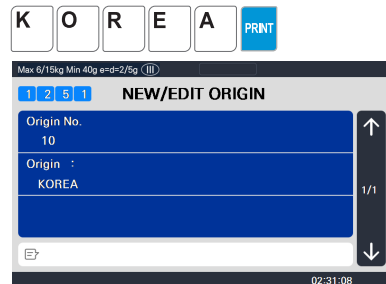

3. Exit Menu

- If you want to exit, press ESC key.



2.2.5.2 List Origin (Menu code 1252)

(MENU → 2. PLU Data Table I → 5. Origin → 2. List)

1. Set the List Range

- Set the range of origin that you wish to check

EX) Origins 1~20

- Press Print Key to List Origins on screen.
After Origins are listed on the screen, pressing the TEST key will print the Origins.

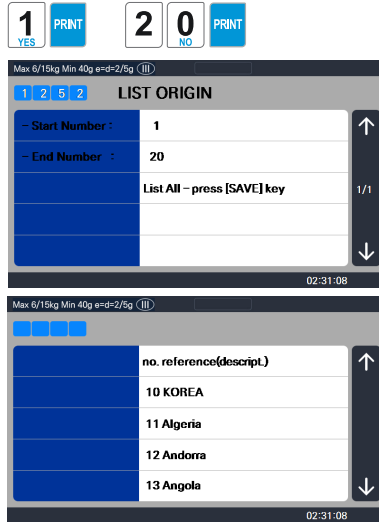

2.2.5.3 Delete Origin (Menu code 1253)

(MENU → 2. PLU Data Table I → 5. Origin → 3. Delete)

1. Enter Origin No.

EX) Delete Origin 10.

Note: There is no confirmation request when deleting a Origin. Pressing the PRINT key will cause the Origin entered to be deleted.

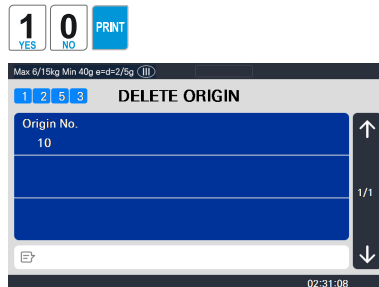

2.2.6 Barcode (Menu code 1260)

(MENU → 2. PLU Data Table I → 6. Barcode)

Up to 99 different Bar Code Formats can be programmed in the CL5000 series.

Different Barcode Formats can be assigned to individual PLU's or one Bar Code Format can be used for all PLU's by enabling the Global Barcode Format Setting (Menu 1520).

2.2.6.1 New/Edit Barcode (Menu code 1261)

(MENU → 2. PLU Data Table I → 6. Barcode → 1. New/Edit)

1. Enter Barcode No.

- This value can be from 1 to 99.

EX) Barcode No = 1



2. Barcode Description.

EX) Barcode Description = EAN13-1

3. Barcode Type

- Reference following table.

EX) Barcode Type = 1. EAN-13

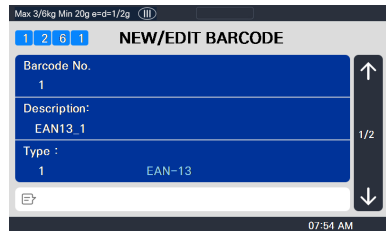

► type of Barcode

No.	Type	Description
1	EAN-13	13digit
2	EAN13A5	13digit + 5digit
3	EAN-8	8 digit
4	I20F5	2~24 digit
5	UPCA	12 digit
6	UPC-13	13 digit
7	CODE39	Alphanumeric character, Format 'T', prints out the name of PLU. 2~13 Character
8	CODE93	Alphanumeric character, Format 'T', prints out the name of PLU. 2~19character
9	CODE128	2~30 digit
10	CODABAR	2~20 digit
11	QR(option)	Alphanumeric character, Format 'T', prints out the name of PLU. 2~13 Character

4. Enter Barcode Form

- You can select from a list of Barcode types or you can create your own custom format
- Refer to following table.

EX) Barcode Form = 1. Change DDIIIIIIIIPPPPPC to GGIIIIIVPPPPC



► The following defines the format characters for Barcode Formats : Example EAN13)

Form No.	Format	Form No.	Format
0	User Defined Barcode	3	DIIIIIIIIIPPPPPC
1	DDIIIIIIIIPPPPPC	4	DIIIIIIIIIPPPPPC
2	DDIIIIIIIIPPPPPC		

► The following defines the format characters for Barcode Formats: (Example)

No.	Symbol	Description
1	I	• item code
2	N	• PLU number
3	P	• price
4	V	• price check digit (It is created automatically)
5	U	• unit price
6	W	• weight
7	Q	• quantity
8	D	• department
9	G	• group
10	K	• country code (For future)
11	A	• ticket counter (Only for ticket)
12	B	• scale transaction counter
13	C	• total barcode check sum (It is created automatically)
14	F	• PLU prefix character
15	T	• text character
16	R	• transaction counter for each PLU
17	L	• clerk number
18	v	• weight check digit (It is created automatically)
19	O	• Packed date
20	S	• Tare value
21	%	• % : print next fixed character*
22	0-9	• numbers

*% : It is used to enter characters therefore you can't use this to enter numbers.

5. Exit Menu

- If you want to exit, press ESC key.



2.2.6.2 List Barcode (Menu code 1262)

(MENU → 2. PLU Data Table I → 6. Barcode → 1. List)

1. Set the list range

- Set the range of barcode that you wish to Check

EX) Barcodes 1~10

- Press Print Key to List Barcodes on screen.
After Barcodes are listed on the screen, pressing the TEST key will print the Barcodes.

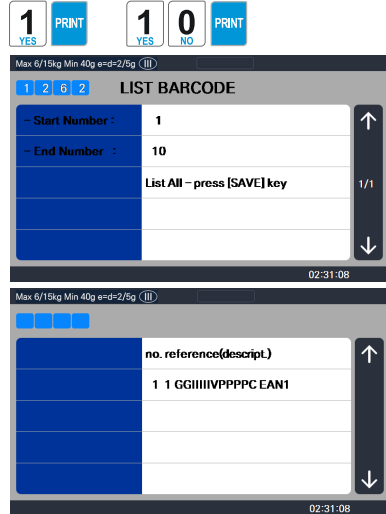

2.2.6.3 Delete Barcode (Menu code 1263)

(MENU → 2. PLU Data Table I → 6. Barcode → 3. Delete)

1. Enter barcode number to delete

EX) Delete barcode 1.

Note: There is no confirmation request when deleting a Barcode. Pressing the PRINT key will cause the Barcode entered to be deleted.

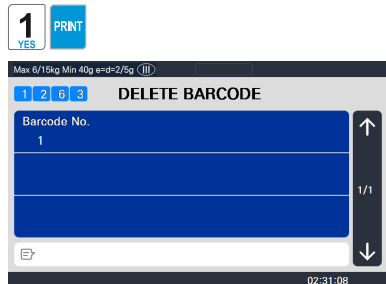

2.2.7 Tare (Menu code 1270)

(MENU → 2. PLU Data Table I → 7. Tare)

The CL5000 series can be programmed to use a Tare No. instead of a numeric value.(System Parameter 584) If you are using Tare Numbers they should be programmed prior to programming any PLU's that use a Tare weight.

Note: Tare weights for use in Tare No.'s can be programmed using the known numeric value or by placing the actual container on the scale.

2.2.7.1 New/Edit Tare (Menu code 1271)

(MENU → 2. PLU Data Table I → 7. Tare → 1. New/Edit)

1. Enter Tare No.

- This value can be from 1 to 99.

EX) Tare No. = 1



2. Tare Description

EX) Tare Description = Container



3. Tare Type

- There are 2 types of Tare Weights that can be entered.

Ex.) Tare Type = 1 Numeric Tare Enter the numeric value using the number keys

Ex.)Tare Type = 2 Weight Type

Place the container on the platter and press the PRINT key after the weight stabilizes.

► Type of Tare

Tare No.	Type of Tare	Description
1	Numeric Tare	Enter tare weight by using numeric keys.
2	Weight Tare	Put a container on the platter

4. Enter Tare Value

EX) Tare = 0.010 Kg



5. Exit Menu

- If you want to exit, press ESC key.
- ※ If you set Tare No. to 1 when you create PLU, tare is set to 0.010kg that is programmed here.



2.2.7.2 List Tare (Menu code 1272)

(MENU → 2. PLU Data Table I → 7. Tare → 2. List)

1. Set the list range

- Set the range of Tare No.'s that you wish to check

EX) Tare No. 1~10

- Press Print Key to List Tare No.'s on screen. After Tare No.'s are listed on the screen, pressing the TEST key will print the Tare No.'s.



2.2.7.3 Delete Tare (Menu code 1273)

(MENU → 2. PLU Data Table I → 7. Tare → 3. Delete)

1. Enter tare number to delete

EX) Delete tare no. 1

Note: There is no confirmation request when deleting a Tare No. Pressing the PRINT key will cause the Tare No. entered to be deleted.

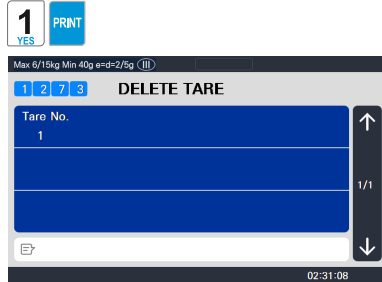

2.2.7.4 Tare Key (Menu code 1274)

(MENU → 2. PLU Data Table I → 7. Tare → 4. Tare Key)

This menu allows you to assign the Tare No.'s (Menu 1271) to Tare Keys. Tare Keys must be programmed using Menu 1880 Function Key Define. There is a maximum of 9 Tare Function Keys available.

Note: When Special Function Keys are programmed they take the place of PLU Speed Keys, reducing the number of Speed Keys accordingly.

1. Enter tare Key.

EX) Tare Key = 1

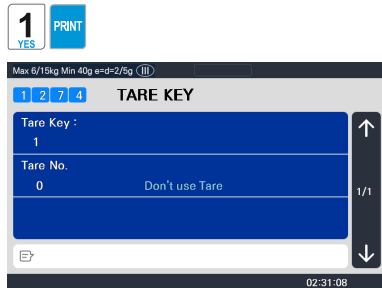

2. Enter tare number

EX) Tare No = 1

Note: Tare No.'s can be 1 to 99.
Tare Keys are 1 to 9 only.

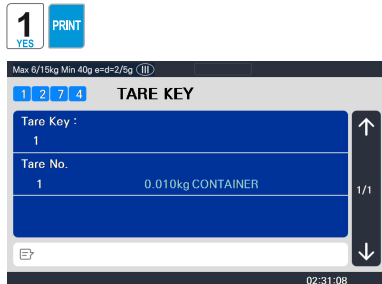

2.2.8 Unit Symbol (Menu code 1280)

(MENU → 2. PLU Data Table I → 8. Unit Symbol)

This menu allows you to program or change the Unit Symbol that will print on the label for Non Weight or By Count PLU's.

2.2.8.1 New/Edit Unit Symbol (Menu code 1281)

(MENU → 2. PLU Data Table I → 8. Unit Symbol → 1. New/Edit)

You can press the SAVE key at anytime to save the current data and if you want to exit without saving, press the ESC key.

1. Enter unit number

- This value can be from 1 to 8.

EX) Qty Unit No. = 1

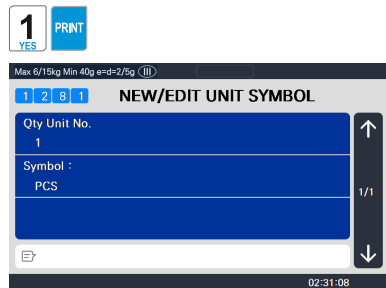

2. Enter unit symbol

EX) Symbol = ™

- ※ If you want to enter special symbol, press the CHAR key and enter the code value. (See ASCII code table on chapter 4.4)

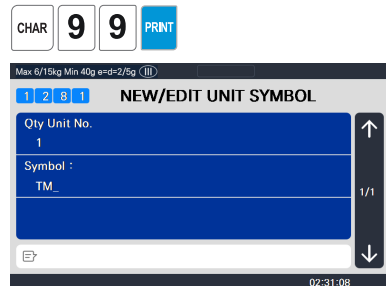

3. Exit menu

- If you want to exit, press ESC key.



2.2.8.2 List Unit Symbol (Menu code 1282)

(MENU → 2. PLU Data Table I → 8. Unit Symbol → 2. List)

1. Set the list range

EX) Unit Symbols 1~8

- Press Print Key to List Unit Symbol No.'s on screen.

After Unit Symbol No.'s are listed on the screen, pressing the TEST key will print the Unit Symbol No.s.

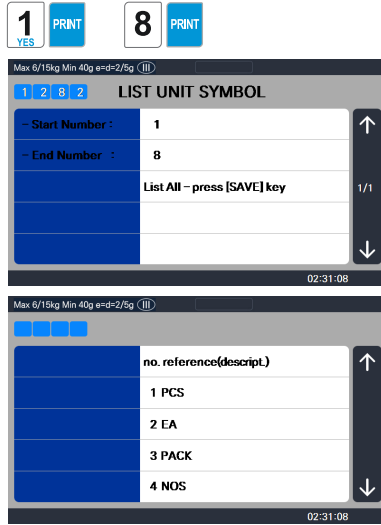

2.2.8.3 Delete Unit Symbol (Menu code 1283)

(MENU → 2. PLU Data Table I → 8. Unit Symbol → 3. Delete)

1. Enter unit symbol number to delete

EX) Delete unit symbol 1.

Note: There is no confirmation request when deleting a Unit Symbol No. Pressing the PRINT key will cause the Unit Symbol No. entered to be deleted.

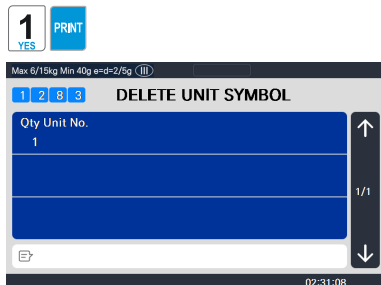

2.3 Programming PLU Data Table II

2.3.1 Ingredient (Menu code 1310)

(MENU → 3. PLU Data Table II → 1. Ingredient)

2.3.1.1 New/Edit Ingredient (Menu code 1311)

(MENU → 3. PLU Data Table II → 1. Ingredient → 1. New/Edit)

- ◆ You can press the SAVE key at anytime to save the current data and if you want to exit without saving, press the ESC key.

1. Enter ingredient number.

- This value can be from 1 to 1000.

EX) Ingredient number = 1

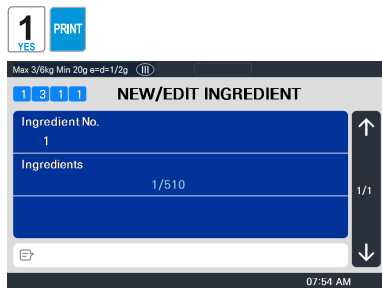

2. Enter ingredient

EX) Ingredient Line1 = SALT

EX) To print "SUGAR" on next line, enter "↵" after SALT.

- Note: The numbers on the right side of the brackets show the total number of characters used and the maximum number of characters for the ingredient message. Pressing the PG UP or PG DOWN key will move the cursor to the beginning or end of the brackets respectively.

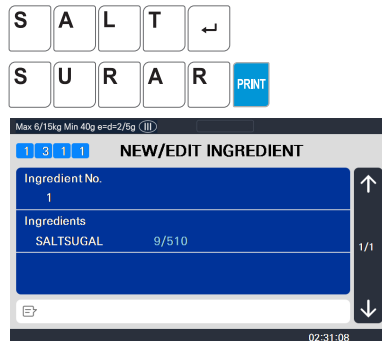

3. Exit menu

- If you want to exit, press ESC key.



2.3.1.2 List Ingredient (Menu code 1312)

(MENU → 3. PLU Data Table II → 1. Ingredient → 2. List)

1. Set the list range

EX) Ingredient No.'s 1~10

- ※ Press Print Key to List Ingredient No.'s on screen.
After Ingredient No.'s are listed on the screen, pressing the TEST key will print the Ingredient No.'s



2.3.1.3 Delete Ingredient (Menu code 1313)

(MENU → 3. PLU Data Table II → 1. Ingredient → 3. Delete)

1. Enter ingredient number to delete

EX) Delete ingredient no. 1

Note: There is no confirmation request when deleting an Ingredient No. Pressing the PRINT key will cause the Ingredient No. entered to be deleted.

Note : **Method of Using** the Ingredient

1.1 Ingredient

Total of 510 characters can be inputted for the Ingredient in the basic setting. These 510 characters can be used by categorizing them into Ingredient1 and Ingredient2. Categorization code exists to distinguish Ingredient1 and 2. This code can be inputted by using the [CHAR] CODE input key. Ingredient1 and Ingredient2 are printed onto separate fields in the label format. Field ID of Ingredient1 is 25, while that for ingredient2 is 26.

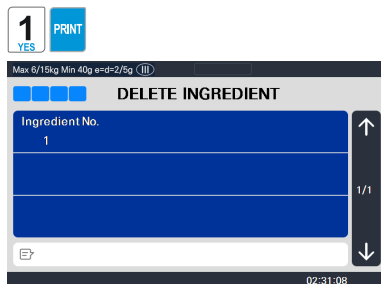

1.2 Inputting of Ingredient at the weighing scale

- (1) Input Ingredient1 at the ingredient input window (MENU 1311).
- (2) After having inputted Ingredient1, press the [CHAR] key to indicate "0000" in the Unit Price box of the VFD window.
- (3) Input categorization code (0x0c). "♀" will be indicated.
[0] + [C] + [PRINT]
- ※ Space (" ") instead of "♀" can be indicated depending on the country.
- (4) After having inputted Ingredient2 after the "♀", press the [SAVE] key.

2.3.2 Nutrition Facts (Menu code 1320)

(MENU → 3. PLU Data Table II → 2. Nutrition Facts)

Using this menu you can program Nutrition Facts information that can be linked to individual PLU's.

Note: The printing size of the Nutrition Facts may vary depending on the label format selected.

► Nutrition Facts table

Nutrition Facts	Description
Serving Size	Text
Serving Per Con	Text
Calories	Cal
Calories From Fat	Cal
Total Fat	g
Saturated Fat	g
Trans Fat	g
Cholesterol	mg
Sodium	mg
Total Carbohydrates	g
Dietary Fibers	g
Sugars	g
Protein	g
Vitamin A	%
Calcium	%
Vitamin C	%
Iron	%
Salt	g

2.3.2.1. New/Edit Nutrition Facts (Menu code 1321)

(MENU → 3. PLU Data Table II → 2. Nutrition Facts → 1. New/Edit)

- ◆ You can press the **SAVE** key at anytime to save the current data and if you want to exit without saving, press the **ESC** key.
- ◆ You can use the **PG UP** and **PG DOWN** keys to navigate from page to page, or you can use the Arrow keys to go through each page 1 line at a time.

1. Nutrition Fact No

- This value can be from 1 to 500.

EX) Nutrition fact no = 1

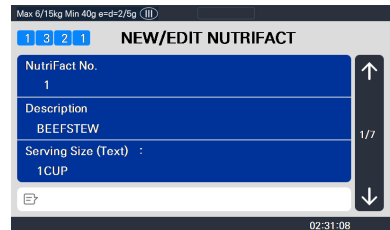
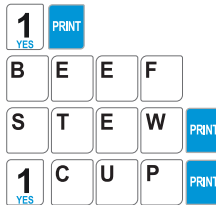

2. Enter description

EX) BEEF STEW

3. Enter Serving Size(Text)

EX) Serving size = 1CUP

4. Serving Per Container(Text)

EX) Serving Per Container = 2

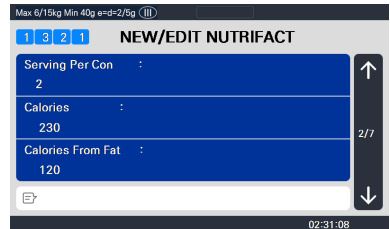
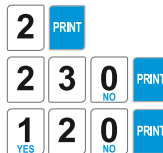

5. Calories

EX) Calories = 230

6. Calories from fat

EX) Calories From Fat= 120

7. Total Fat(g)

EX) Total fat = 14 g

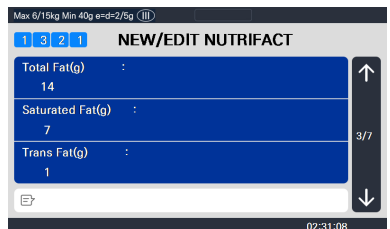

8. Saturated fat(g)

EX) Saturated fat = 7 g

9. Trans Fat(g)

EX) Trans Fat = 1 g

10. Cholesterol(mg)

EX) Cholesterol = 40 mg

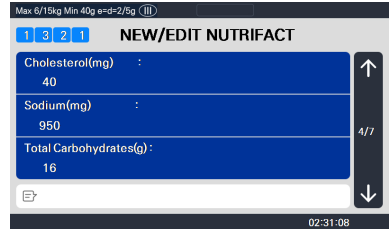
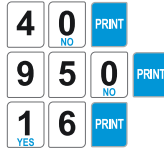

11. Sodium(mg)

EX) Sodium = 950 mg

12. Total Carbohydrate(g)

EX) Total Carbohydrate = 16 g

13. Dietary Fibers(g)

EX) Dietary Fiber = 2 g

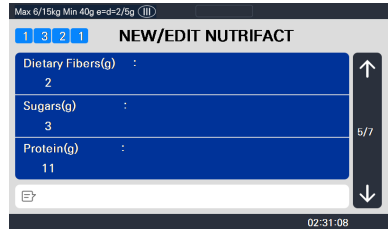

14. Sugars(g)

EX) Sugars = 3 g

15. Protein(g)

EX) Protein = 11 g

16. Vitamin A(%)

EX) Vitamin A = 20%

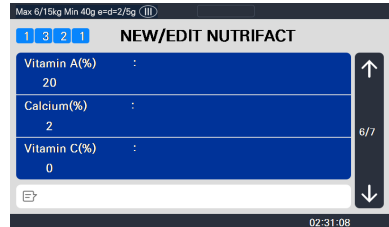

17. Calcium(%)

EX) Calcium = 2%

18. Vitamin C(%)

EX) Vitamin C = 0 %

19. Iron(%)

EX) Iron = 6 %

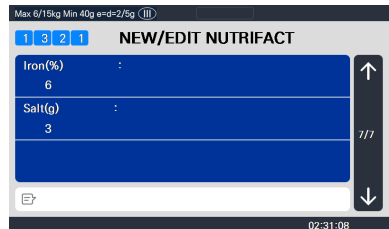

20. Salt(g)

EX) Salt = 3 g

2.3.2.2 List Nutrition Facts (Menu code 1322)

(MENU → 3. PLU Data Table II → 2. Nutrition Facts → 2. List)

1. Set the list range

EX) Nutrition Fact No.'s 1~10

- Press Print Key to List Nutrition Fact No.'s on screen. After Nutrition Fact No.'s are listed on the screen, pressing the TEST key will print the Nutrition Fact No.'s.

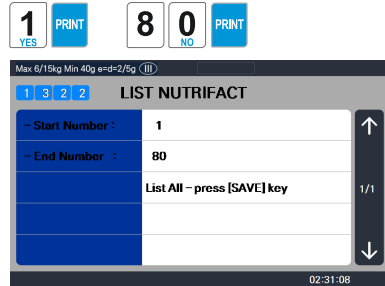

2.3.2.3 Delete Nutrition Facts (Menu code 1323)

(MENU → 3. PLU Data Table II → 2. Nutrition Facts → 3. Delete)

1. Enter nutrition fact number to delete.

EX) Delete nutrition facts no.1

Note: There is no confirmation request when deleting a Nutrition Fact No. Pressing the PRINT key will cause the Nutrition Fact No. entered to be deleted.



2.4 Discount Programming

2.4.1 Discount (Menu code 1130)

(MENU → 1. PLU → 3. Discount)

The Discount Programming Menu is used to program promotional pricing for individual PLU's. Discount pricing can be accomplished using Menu code 1130 or by using the CL-Works Software. Discount information must be programmed in each PLU.

2.4.1.1 New/Edit Discount (Menu code 1131)

(MENU → 1. PLU → 3. Discount → 1. New/Edit)

- ◆ You can use the PG UP and PG DOWN keys to navigate from page to page, or you can use the Arrow keys to go through each page 1 line at a time.

1. Enter department number and PLU number.

EX) Department Number = 1
 PLU Number = 1

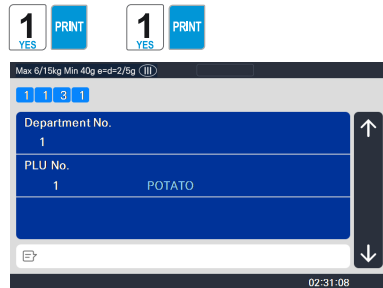

2. Enter discount type

- Refer to Discount Type table as below
- ※ Discount information can be different depending on the discount type.

EX) 1. Unit Price Discount

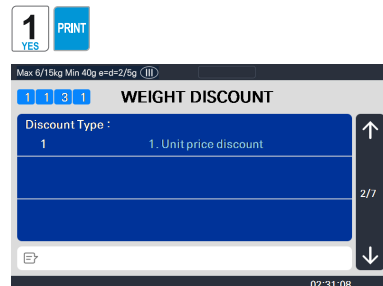

► Discount Type

#	Type	Description
1	Unit Price Discount	- By Weight PLU: Set the discount amount on unit price, depending on weight. - By Count/PCS PLU: Set the discount amount on unit price, depending on number of items.
2	% Unit Price Discount	- By Weight PLU: set discount % of unit price, depending on weight. - By Count/PCS PLU: set discount % of unit price, depending on number of items.
3	Total Price Discount	- Set discount amount for total price.
4	% Total Price Discount	- Set discount % of total price.
5	Fixed Price	- Set a fixed amount for discount.
6	Free Item	- Set free of charge item.
7	Free Addition	- By Weight PLU: Set discount weight. - By Count/PCS PLU: Set discount number
8	Total Price by total price	- Set a discount amount of total price for current total price.
9	% Total Price by Total Price	- Set a discount % of total price for current total price
10	Unit Price by Total Price	- Set a discount amount of unit price for current total price
11	Extra by Total Price	- Set a discount number of item for current total price
12	Unit Price Discount +	- Similar to #1 type 'Unit Price Discount', but it shows discounting price, not discounted price.
13	Free Item +	- Buy N get 1 for free.

※ Please refer to “Parameter” when user wants to also see the unit price discounted on “Unit Price” segment together with total price discounted in display

3. Enter discount value

- Refer to below table.

※ Target unit is different depending on the PLU type. This is By Weight PLU therefore this unit is weight. In case of By count PLU or By PCS PLU, unit is count.

EX) 1st Target: 0.100 Kg
 1st Value: 1.00 \$
 2nd Target: 0.500 Kg
 2nd Value: 2.00 \$

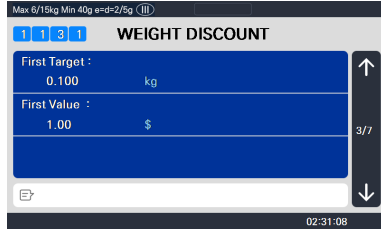

No.	Type	Description
1	First Target Weight	Set weight limit for 1st stage of discount.
2	First Value Price	Set the discount amount of unit price for the first weight limit.
3	Second Target Weight	Set weight limit for 2nd stage of discount.
4	Second Value Price	Set the discount amount of unit price for the second weight limit.

4. Discount Condition 1: (Set the day of week)

- 1 → Discount
 - 0 → Do not discount
- EX) Discount on Thursday, Friday and Saturday

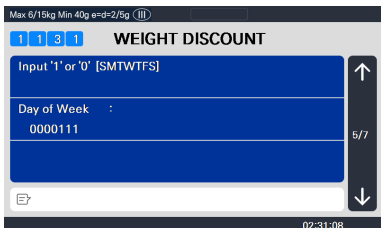

**5. Discount Condition 2
(Set date and time)**

- If you set date and time to 0, it means discount all the time

EX) Start Date: 01-07-04
End Date : 31-07-04

EX) Start Time: 8am
End Time: 6:30pm

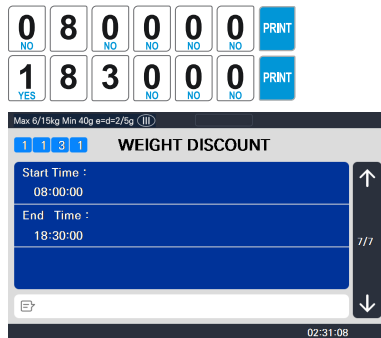
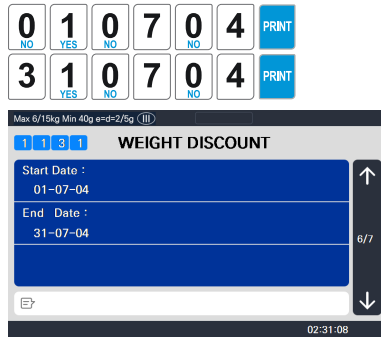

6. Exit menu

- If you want to exit, press the ESC key.



2.4.1.2 List Discount (Menu code 1132)

(MENU → 1. PLU → 3. Discount → 2. List)

1. Enter department number to check

EX) Department No 1.

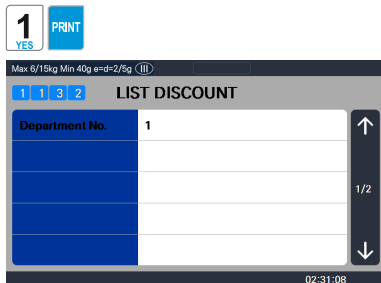

2. Enter PLU range to check

EX) PLU No.'s 1~10

Press Print Key to List Discount type of PLU No.'s on screen.

After Discount type of PLU No.'s are listed on the screen, pressing the TEST key will print the Discount type of PLU No.'s.



2.4.1.3 Delete Discount (Menu code 1133)

(MENU → 1. PLU → 3. Discount → 3. Delete)

◆ There are three ways to delete Discount. Simply enter the number that you wish to delete.

1) Delete by PLU No. (DC) (Menu code 1137)

(MENU → 1. PLU → 3. Discount → 3. Delete → 1. Delete by PLU no.(DC))

EX) Press 1 key to select Delete by PLU No.(DC)

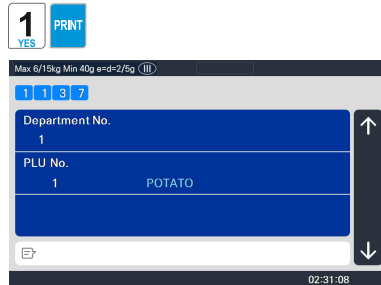

1. Enter the department number and PLU number to delete

EX) Department number = 2
PLU No. = 1

Note: There is no confirmation request when deleting a Discount of a PLU No. Pressing the PRINT key will cause the Discount of the PLU No. entered to be deleted.

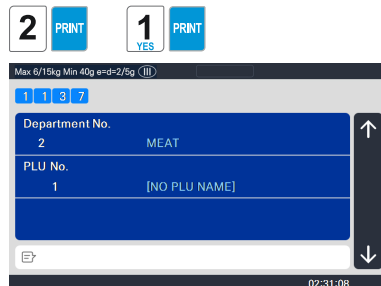

2) Delete by Dept. No. (DC) (Menu code 1138)

(MENU → 1. PLU → 3. Discount → 3. Delete → 2. Delete by Dept. No (DC))

1. Enter the department number to delete

EX) Department number = 2

Note: There is no confirmation request when deleting a Discounts by Department No. Pressing the PRINT key will cause all Discounts in the Department Number entered to be deleted.

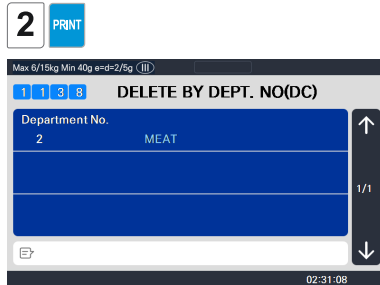

3) Delete ALL (DC) (Menu code 1139)

(MENU → 1. PLU → 3. Discount → 3. Delete → 3. Delete ALL(DC))

Press 1 key to select Delete all (DC)

Note: There is no confirmation request when deleting all Discounts. Pressing the PRINT key will cause All Discounts in all Departments to be deleted.

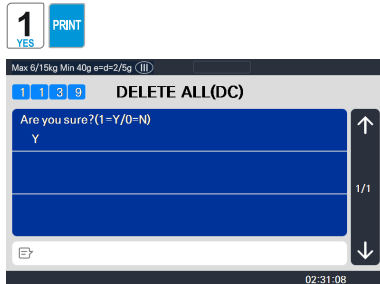

2.5 Global Discount Programming

2.5.1 Global Discount (Menu code 1530)

(MENU → 5. Global Setting → 3. Discount)

This menu is used to select what type of Discount is applied to a PLU. You can select to use a Global Discount for all PLU's, apply Discounts based on individual PLU's or use no Discount at all. Refer to the chart below for all options.

2.5.1.1 Priority Setting (Menu code 1531)

(MENU → 5. Global → 3. Discount → 1. Priority setting)

This menu is used to determine which Discount will have priority. Refer to the chart below.

Note: Discount information can be seen on the display using Menu code 1871.
(See chapter 2.14.7) Discount information is also printed on the label.

► Discount Priority Setting

No	Type	Description
0	No Discount	No discount applied
1	PLU Discount	PLU discount only applied
2	Global Discount	Global discount only applied
3	No Discount in PLU then Global	PLU discount is applied. If there is no PLU discount, apply global discount

2.5.1.2 Weight/Count/PCS Discount (Menu code 1532/1533/1534)

(MENU → 5. Global → 3. Discount → 1. Priority)

If you want to use the Global Discount method and apply the same discount regardless of PLU, you can set the Discount information in Menu code 1532, 1533 and 1534. You can use the same procedures shown in chapter 2.4.1.1

Global Discount condition by weight Item (Menu code 1532)

(MENU → 5. Global Setting → 3. Discount → 2. Weight discount)

Global Discount condition by Count Item (Menu code 1533)

(MENU → 5. Global Setting → 3. Discount → 3. Count discount)

Global Discount condition by PCS Item (Menu code 1534)

(MENU → 5. Global Setting → 3. Discount → 4. PCS discount)

2.6 Speed Key Setting (Menu code 1160)

(MENU → 1. PLU → 6. Speed Key)

This menu is used to program Speed keys. Speed keys are short-cut keys used to allow quick access to the most frequently used PLU's in a department. There is also a SHIFT function that allows you to set a second level of Speed keys that will double the number of Speed keys available in a department.

You can program up to 5 different Speed Key Sets but only one set can be used in a department at a time. The Speed Key Set that is used in a department is determined by Menu code 1211 (chapter 2.2.1.1)

Note: Function keys can be programmed using Menu code 1880 (chapter 2.14.8) and are assigned to Speed Key locations. If you program Function keys on the CL5000 series you will decrease the total number of Speed Keys available.

1. Speed Key Set No.

- Select speed key set no. You can use this number when you program menu 1211. (See the chapter 2.2.1.1)

EX) Speed key set No. = 2

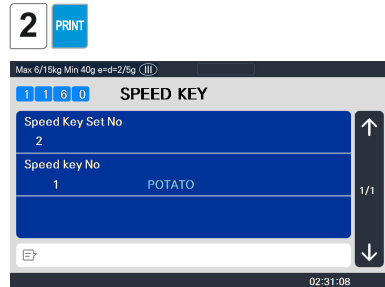

2. Speed Key Programming

- there are 72 keys if you press the SHIFT key and then one of the 72 Speed keys, then you can access Speed keys 73 through 144

EX1) Speed key no. 1 (A)
 EX2) Speed key no. 49 (SHIFT + A)

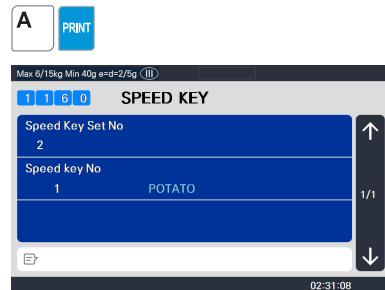

3. PLU No.

- Enter PLU no. to assign speed key
- PLU should be belong to scale department.

EX1) PLU 1 = POTATO

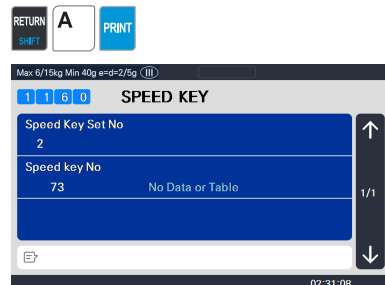

2.7 Traceability

2.7.1 Traceability (Menu code 1330)

(MENU → 3. PLU Date Table II → 3. Traceability)

This Menu is used to program the history of a PLU. You must follow local Traceability regulations when using this menu.

Note: You should program the Country Code (Menu 1340), Slaughter House (Menu 1350) and Cutting Hall (Menu 1360) before programming the Traceability.

2.7.1.1 New/Edit Traceability (Menu code 1331)

(MENU → 3. PLU Date Table II → 3. Traceability → 1. New/Edit)

► You can press the SAVE key at anytime to save the current data and if you want to exit without saving, press the ESC key.

1. Enter traceability number

• This value can be from 1 to 99.

EX) Traceability number = 1

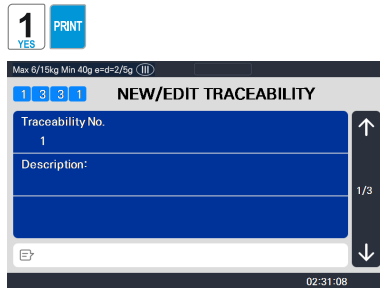

2. Enter description

EX) Description = SIRLOIN



3. Born in country number

EX) Born in country No. = 1. SWEDEN



4. Bred in country number

EX) Bred in country No. = 95. KOREA



5. Slaughter house number

EX) Slaughter house No. = 12. BILLY S

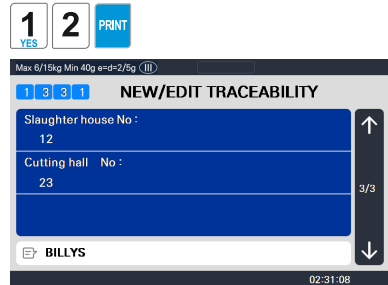

6. Cutting hall number

EX) Cutting hall No. = 23. HAN S CUT



7. Exit menu

- If you want to exit, press ESC key.



2.7.1.2 List Traceability (Menu code 1332)

(MENU → 3. PLU Date Table II → 3. Traceability → 2. List)

1. Set the list range

- Ex.) Traceability No.'s 1~10

Press Print Key to List Traceability No.'s on Screen.

After Traceability No.'s are listed on the screen, pressing the TEST key will print the Traceability No.'s.

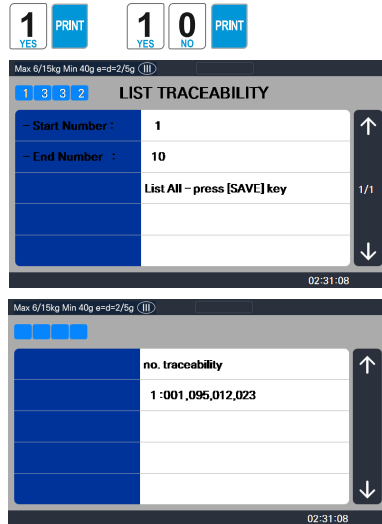

2.7.1.3 Delete Traceability (Menu code 1333)

(MENU → 3. PLU Date Table II → 3. Traceability → 3. Delete)

1. Enter traceability number to delete

EX) Delete traceability no. 2

Note: There is no confirmation request when deleting a Traceability No. Pressing the PRINT key will cause the Traceability No. entered to be deleted.



2.8 Country Programming

2.8.1 Country (Menu code 1340)

(MENU → 3. PLU Date Table II → 4. Country)

This menu is used to program Country information. Country information is used when programming Traceability Numbers. Therefore Country information programming should be completed prior to programming Traceability. (Menu 1330)

2.8.1.1 New/Edit Country (Menu code 1341)

(MENU → 3. PLU Date Table II → 4. Country → 1. New/Edit)

- ▶ You can press the SAVE key at anytime to save the current data and if you want to exit without saving, press the **ESC** key.

1. Enter country number

- This value can be from 1 to 999.

EX) Country No. = 1



2. Enter country name

EX) Name = KOREA

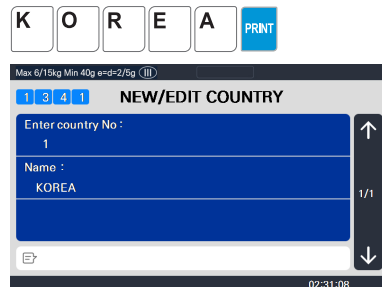

3. Exit menu

- If you want to exit, press ESC key.



2.8.1.2 List Country (Menu code 1342)

(MENU → 3. PLU Date Table II → 4. Country → 2. List)

1. Set the list range

- Set the list range to check

EX) Country No.'s 1-10

Press Print Key to List Country No.'s on screen.

After Country No.'s are listed on the screen, pressing the TEST key will print the Country No.'s.

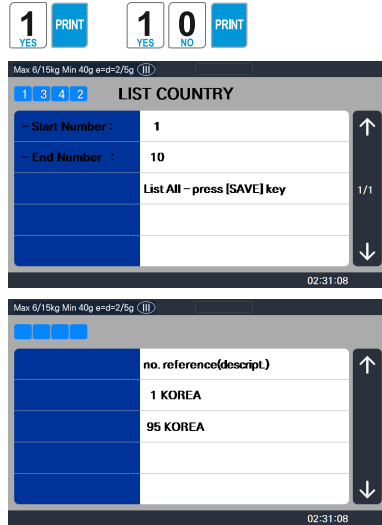

2.8.1.3 Delete Country (Menu code 1343)

(MENU → 3. PLU Date Table II → 4. Country → 3. Delete)

1. Enter country number to delete

EX) Delete country no. 1

Note: There is no confirmation request when deleting a Country No. Pressing the PRINT key will cause the Country No. entered to be deleted.



2.9 Programming Slaughter House

2.9.1 Slaughter House (Menu code 1350)

(MENU → 3. PLU Date Table II → 5. Slaughter House)

This menu is used to program Slaughter House information. Slaughter House information is used when programming Traceability Numbers. Therefore Slaughter House information programming should be completed prior to programming Traceability. (Menu 1330)

2.9.1.1 New/Edit Slaughter House (Menu code 1351)

(MENU → 3. PLU Date Table II → 5. Slaughter House → 1. New/Edit)

- ▶ You can press the **SAVE** key at anytime to save the current data and if you want to exit without saving, press the **ESC** key.

1. Enter slaughter House number

- This value can be from 1 to 999.

EX) Slaughter house No. = 1

The screenshot shows the 'NEW/EDIT SLAUGHTER HOUS' menu. At the top, there are navigation buttons: '1 YES', '3', '5', and '1'. The main display area contains the following fields: 'Enter slaughter house No:' with the value '1', 'House:' with the value '1', and 'Country:' with the value '0' and a note 'No Data or Table'. On the right side, there are up and down arrow keys and a '1/1' indicator. At the bottom right, the time '02:31:08' is displayed.

2. Enter Slaughter House

- Enter slaughter house name or registered number.

EX) Slaughter house registered no. = KSH12

The screenshot shows the 'NEW/EDIT SLAUGHTER HOUS' menu. At the top, there are navigation buttons: 'K', 'S', 'H', '1 YES', '2', and 'PRINT'. The main display area contains the following fields: 'Enter slaughter house No:' with the value '1', 'House:' with the value 'KSH12', and 'Country:' with the value '1' and 'KOREA'. On the right side, there are up and down arrow keys and a '1/1' indicator. At the bottom right, the time '02:31:08' is displayed.

3. Enter slaughter house country number

- You can use country number which is programmed at menu 1341

EX) Slaughter house Country No. = 1.
KOREA

The screenshot shows the 'NEW/EDIT SLAUGHTER HOUS' menu. At the top, there are navigation buttons: '1 YES', '3', '5', and '1'. The main display area contains the following fields: 'Enter slaughter house No:' with the value '1', 'House:' with the value 'KSH12', and 'Country:' with the value '1' and 'KOREA'. On the right side, there are up and down arrow keys and a '1/1' indicator. At the bottom right, the time '02:31:08' is displayed.

4. Exit menu

- If you want to exit without making any changes, press ESC key.



2.9.1.2 List Slaughter House (Menu code 1352)

(MENU → 3. PLU Date Table II → 5. Slaughter House → 2. List)

1. Set the list range

- Enter list range to check

EX) Slaughter House No.'s 1~10

Press Print Key to List Slaughter House No.'s on screen.

After Slaughter House No.'s are listed on the screen, pressing the TEST key will print the Slaughter House No.'s.



2.9.1.3 Delete Slaughter House (Menu code 1353)

(MENU → 3. PLU Date Table II → 5. Slaughter House → 3. Delete)

1. Enter slaughter House number

- 1. Enter slaughter house number to delete

EX) Delete slaughter house no. 1

Note: There is no confirmation request when deleting a Slaughter House No. Pressing the PRINT key will cause the Slaughter House No. entered to be deleted.



2.10 Programming Cutting Hall

2.10.1 Cutting Hall (Menu code 1360)

(MENU → 3. PLU Date Table II → 6. Cutting Hall)

This menu is used to program Cutting Hall information.

Cutting Hall information is used when programming Traceability Numbers. Therefore Cutting Hall information programming should be completed prior to programming Traceability. (Menu 1330)

2.10.1.1 New/Edit Cutting Hall (Menu code 1361)

(MENU → 3. PLU Date Table II → 6. Cutting Hall → 1. New/Edit)

- ▶ You can press the **SAVE** key at anytime to save the current data and if you want to exit without saving, press the **ESC** key.

1. Enter cutting hall number

- This value can be from 1 to 99

EX) Cutting hall no. = 1

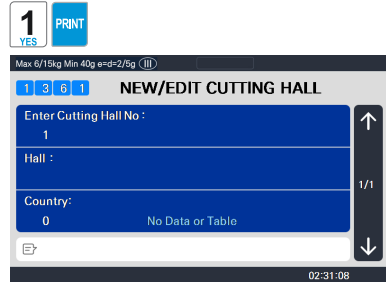

2. Enter cutting hall information

- Enter cutting hall name or registered number.

EX) Cutting hall registered number = KCH12

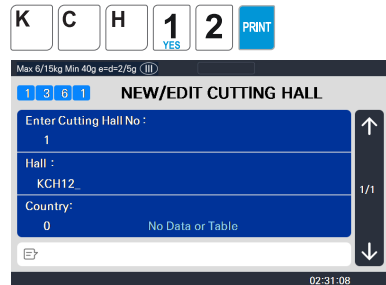

3. Cutting hall Country number

- You can use country number which is programmed at menu 1341 (See chapter 2.8.1.1)

EX) Cutting Hall Country no. = 1.
KOREA

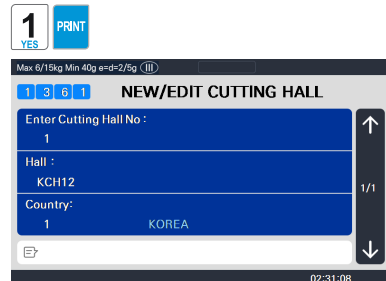

4. Exit menu

- If you want to exit, press ESC key.



2.10.1.2. List Cutting Hall (Menu code 1362)

(MENU → 3. PLU Date Table II → 6. Cutting Hall → 2. List)

1. Set the list range

- Set the list range to check

EX) Cutting Hall No.'s 1~10

- Press Print Key to List Cutting Hall No.'s on screen.

After Cutting Hall No.'s are listed on the screen, pressing the TEST key will print the Cutting Hall No.'s.

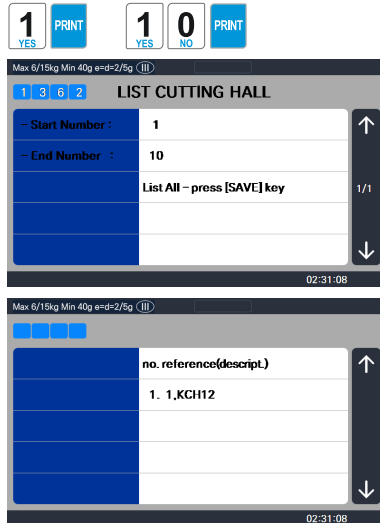

2.10.1.3 Delete Cutting Hall (Menu code 1363)

(MENU → 3. PLU Date Table II → 6. Cutting Hall → 3. Delete)

1. Enter cutting hall number to delete

EX) Delete cutting hall no. 1

Note: There is no confirmation request when deleting a Cutting Hall No. Pressing the PRINT key will cause the Cutting Hall No. entered to be deleted.

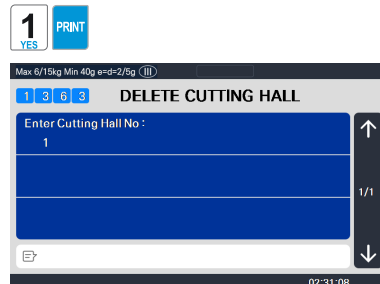

2.11 Programming Store Data

This chapter explains how to access and program Store Data, Customer Information, Scrolling Messages and Currency Data.

2.11.1 Store Data (Menu code 1410)

(MENU → 4. Store Data Table → 1. Store)

This menu shows how to program Store Data information.

2.11.1.1 New/Edit Store (Menu code 1411)

(MENU → 4. Store Data Table → 1. Store → 1. New/Edit Store)

1. Enter store number.

EX) #1

2. Press PRINT key and enter appropriate text in NAME .

EX) NAME = CAS STORE

3. Press PRINT key, then user may enter other store information such as TELEPHONE NUMBER

EX) TEL.#=2019339002,

4. Press PRINT key and enter any text Information

EX) TEXT=NJ CAS office

4. Press PRINT key and user may go back to STORE main menu by using ESC key.

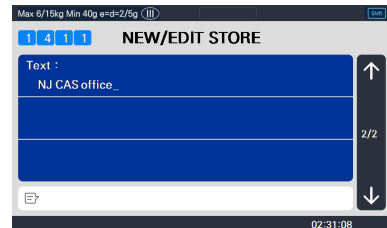

2.11.1.2 List Store (Menu code 1412)

(MENU → 4. Store Data Table → 1. Store → 2. List Store)

- ➔ This menu shows the list of STORE saved.
- ➔ Press 2 in STORE menu to get into LIST STORE menu.
- ➔ Press SAVE key to list all of STORE information saved.

1. Set the list range

- Set the list range to check

EX) Store No.'s 1~10

Press Print Key to List Store No.'s on screen.

After Store No.'s are listed on the screen, pressing the TEST key will print the Store No.'s.

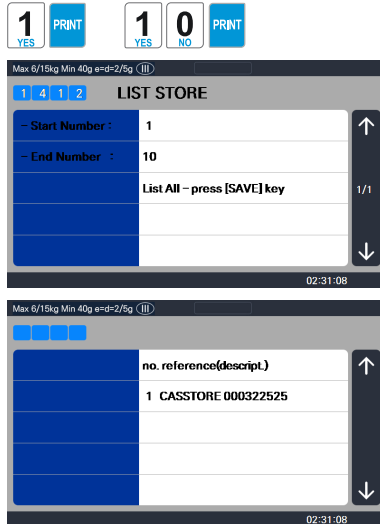

2.11.1.3 Delete Store (Menu code 1413)

(MENU → 4. Store Data Table → 1. Store → 3. Delete Store)

- ➔ This menu is to delete the STORE user wish to.
- ➔ Press 3 in STORE menu to get into DELETE STORE menu.

1. Store delete

EX) Store. 1

Note: There is no confirmation request when deleting a Store No. Pressing the PRINT key will cause the Store No. entered to be deleted.



2.11.2 Customer (Menu code 1420)

(MENU → 4. Store Data Table → 2. Customer)

This Menu is used to program the Customer Information.

Customer Information is used to manage a specific Customer's Accounts Receivable. It is used in the Clerk Mode when issuing a receipt for a Credit Transaction.

EX) Pre-paid Customer, Monthly payment, etc.

2.11.2.1 New/Edit Customer (Menu code 1421)

(MENU → 4. Store Data Table → 2. Customer → 1. New/Edit)

1. Enter Customer number and press "PRINT" key.

EX) Customer No.=1,

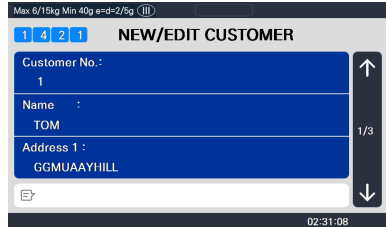

2. Enter other informations in [], such as Name, Address1, and Address2.

EX) NAME=TOM

ADDRESS 1=99 Murry hill.

ADDRESS 2=East ford

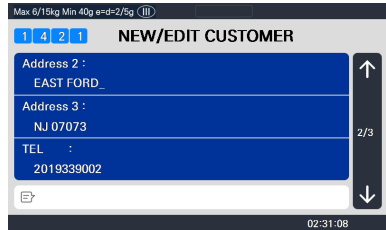
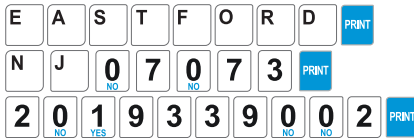

3. Press "PRINT" key, then user may enter the Address 3, TEL. Number and customer s CREDIT LIMIT AMOUNT.

EX) ADDRESS 3=NJ 07073

TEL=2019339002

CREADIT LIMIT AMOUNT0=200.00

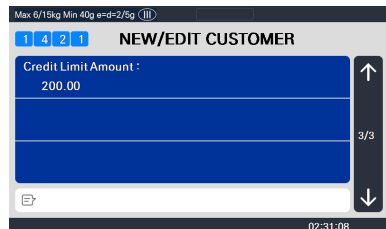

- Press "PRINT" key, to enter the information.
User may go back to main CUSTOMER menu by pressing "X/ESC" key.



2.11.2.2 List Customer (Menu code 1422)

(MENU → 4. Store Data Table → 2. Customer → 2. List)

This Menu allows you to list the Customer No.'s on the screen or print them out for your records.

1. Set the list range

- Set the list range to check

EX) Customer No.'s 1~10

- Press Print Key to List Customer No.'s on screen.

After Customer No.'s are listed on the screen, pressing the TEST key will print the Customer No.'s.



2.11.2.3 Delete Customer (Menu code 1423)

(MENU → 4. Store Data Table → 2. Customer → 3. Delete)

This Menu allows you to Delete a Customer from the file.

1. Enter customer to delete

EX) Delete customer NO.=1

Note: There is no confirmation request when deleting a Customer No. Pressing the PRINT key will cause the Customer No. entered to be deleted.

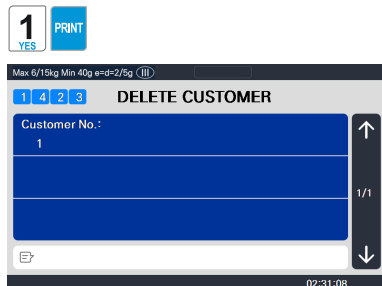

2.11.3 Currency (Menu code 1440)

(MENU → 4. Store Data Table → 4. Currency)

User may save rate of currency to default currency and convert to another currency simply by this function.

☞ Please refer to Menu 1880 Function key definition.

2.11.3.1 New/Edit Currency (Menu Code 1441)

(MENU → 4. Store Data Table → 4. Currency → 1. New/Edit)

1. Numbering Currency

- You can save up to 4 different currencies by numbering 1-4.

EX) Currency No. = 1

2. Rate Decimal Point

- Enter the Rate Decimal Point (default = 4)

EX) Rate Decimal Point = 3

3. Currency Rate.

- Enter comparative rate of currency to default currency set.

EX) Default currency = \$1.00

Comparative currency rate to default

Currency

= 12.800.

4. Primary Sign

- Enter the first currency sign to be changed.

EX) Primary Sign = €

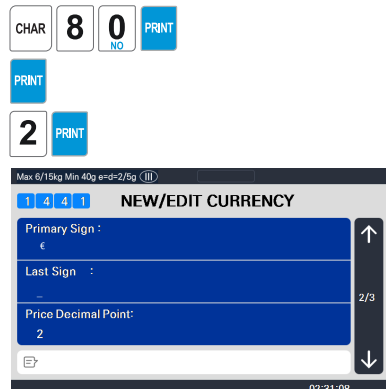
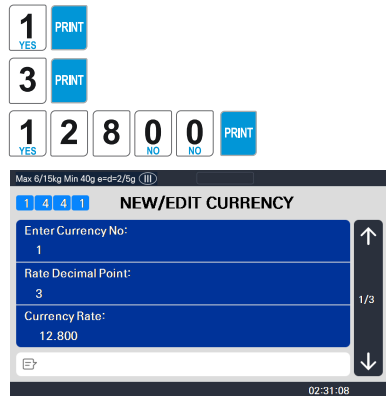

5. Last Symbol

- Enter the last currency symbol to be changed.

EX) No last symbol

6. Price Decimal Digit

- Enter the number of decimal digit

EX) Price Decimal point digit = 2

7. Price Output Format

- Enter the number of format

EX) Price Output Format = 2

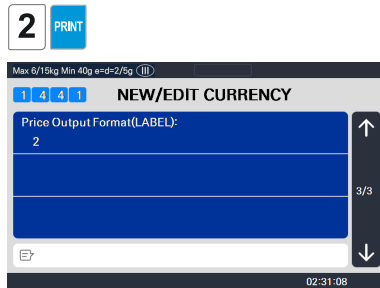

► Printing Output formats of currency symbol

No	Printing Format	Description
0	100.00, 0.12	
1	\$ 100.00, \$ 0.12	
2	100.00 \$, 0.12\$	
3	\$ 100.00 c, \$0.12c	
4	\$ 100.00 c, 12c(Greek)	When total amount is less than 1, only Last currency symbol shows up.
5	\$100.00, \$0.12	
6	100.00\$, 0.12\$	
7	\$100.00c, \$0.12c	
8	\$100.00c, 12c(Greek)	When total amount is less than 1, only Last currency symbol shows up.

2.11.3.2 List Currency (Menu Code 1442)

(MENU → 4. Store Data Table → 4. Currency → 2. List)

1. Set the list range

- Set the list range to check

EX) Currency No.'s 1~4

- Press Print Key to List Currency No.'s on screen.

After Currency No.'s are listed on the screen, pressing the TEST key will print the Currency No.'s.

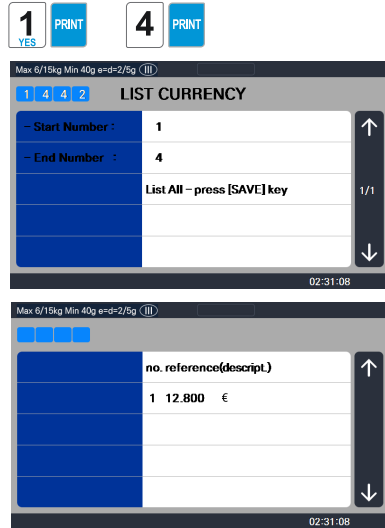

2.11.3.3 Delete Currency (Menu code 1443)

(MENU → 4. Store Data Table → 4. Currency → 3. Delete)

1. Currency number to delete

EX) Delete Currency no. 2

Note: There is no confirmation request when deleting a Currency No. Pressing the PRINT key will cause the Currency No. entered to be deleted.

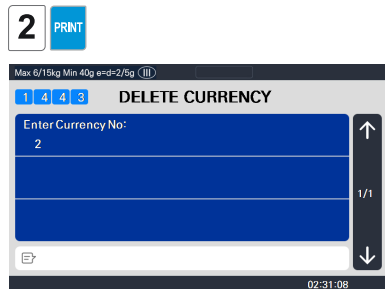

2.11.4 Job Batch Schedule (Menu code 1450)

(MENU → 4. Store Data Table → 5. Job Batch Schedule)

This function is used to print the label in large number for the pieced products or to sell several pieced products that have been packaged into a set.

2.11.4.1 New/Edit Job Batch Schedule (Menu code 1451)

(MENU → 4. Store Data Table → 5. Job Batch Schedule → 1. New/Edit Schedule)

1. Job Batch No.

- Enter the number of Job Batch Schedule to create.
You can use 1-10.



2. Department No.

- Enter the umber of Department to call.

3. PLU No.

- Enter the number of PLU to call.

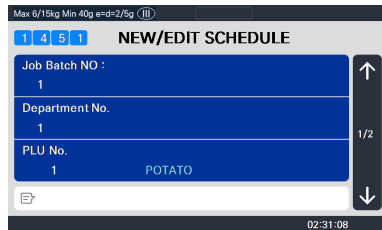

Note : This PLU must belong to count or PCS type

4. Label Print Quantity

- Enter the total number of label printing to print.
You can enter 1-99.

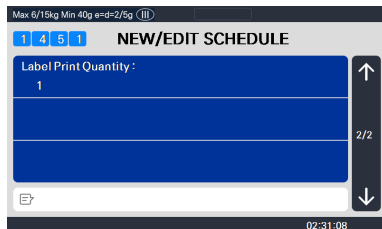

2.11.4.2 List Job Batch Schedule (Menu code 1452)

(MENU → 4. Store Data Table → 5. Job Batch Schedule → 2. List Schedule)

1. Set the list range

- Set the list range to check

EX) Job Batch Schedule No.'s 1~10

2.11.4.3 Delete Job Batch Schedule (Menu code 1453)

(MENU → 4. Store Data Table → 5. Job Batch Schedule → 3. Delete Schedule)

1. Job Batch Schedule number to delete

EX) Delete Job Batch Schedule no. 2

Note: There is no confirmation request when deleting a Job Batch Schedule No. Pressing the PRINT key will cause the Job Batch Schedule No. entered to be deleted.

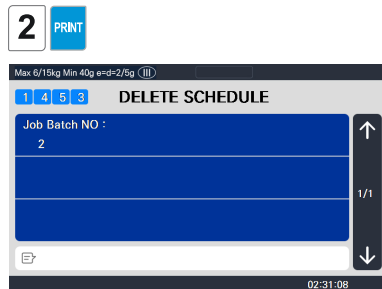

2.11.5 Scanner (Menu code 1460)

(MENU → 4. Store Data Table → 6. Scanner)

This menu is used to make barcode scanning sale available or just to call up PLU.

These are operable functions and setting methods when using by connecting the barcode scanner to CL5000 series.

2.11.5.1 New/Edit Scanner Conversion Table (Menu code 1461)

(MENU → 4. Store Data Table → 6. Scanner → 1. New/Edit Conv Table)

This is Mapping Table between each scanned bar code and each PLU number.

1. Setting up scan code No

Maximum number of Conv Table. Index is 1999

2. Setting up mapping Code

Enter the number ranged between 1 and 13.

3. Setting up department No

Enter the Department number of the PLU to be mapped.

4. Setting up PLU No

Enter the PLU number to be mapped.

EX)

Index	The value to be compared with data from a bar code	Department and PLU no. to be mapped	
Code No	Mapping Code	Department No	PLU No
1	2855551	1	1
2	2855552	1	5
~	~	~	~
1999	2867890	1	220

2.11.5.2 List Scanner Conversion Table (Menu code 1462)

(MENU → 4. Store Data Table → 6. Scanner → 2. List Conv Table)

1. Set the list range

- Set the list range to be checked

EX) Scanner Conversion Table No. 1~1999

- Press Print Key to List Conversion Table No.'s on screen. After Conversion Table No.'s are listed on the screen, pressing the TEST key will print the Conversion Table No.'s.

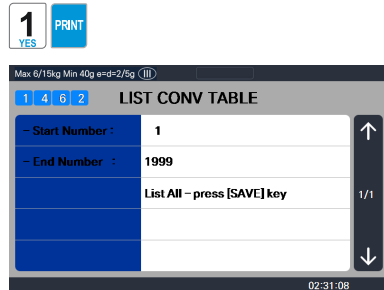

2.11.5.3 Delete Scanner Conversion Table (Menu code 1463)

(MENU → 4. Store Data Table → 6. Scanner → 3. Delete Conv Table)

1. Enter the number of Conversion Table to be deleted

EX) Delete Conversion Table no. 2

Note: There is no confirmation request when deleting a Table No. Pressing the PRINT key will cause the Conversion Table No. entered to be deleted.



2.11.5.4 Scanner Config (Menu code 1464)

(MENU → 4. Store Data Table → 6. Scanner → 4. Scanner Config)

1. The way to set up Scan Form

Enter defined 13-digit number or letter that scanner can recognize.

Assigned representative characters are written below.

You can set the 10 configuration of Scanner.

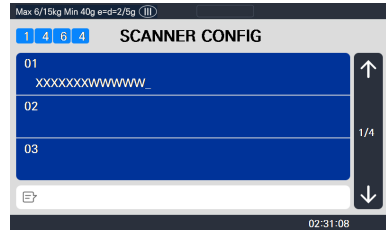
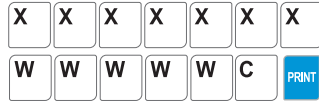

-“X” character : It must be the number of same digit length as “Mapping Code”, that you entered above, has.

-“W” character : It represents weight date.

Any other symbol than “X”, “W” is ignored when scanning.

Example 1) Scan Form : [XXXXXXXWWWWWWC]

- From 1 to 7 digits “XXXXXXX” calls PLU comparing with Mapping Code entered above 4).

- From 8 to 12 digits “WWWWW” shows the value of weigh.

Example 2) Scan Form : [00XXXXX000000]

- From 3 to 5 digits “XXXXX” calls PLU by comparing with Mapping Code.

At this time, you must enter 5 digits as Mapping Code in menu1461.

Example 3) Scan Form : [XXXXXXXXXXXXX]

- The 13 digits bar code is calls PLU by comparing with Mapping Code.

At this time, you must enter 13 digits as Mapping Code at menu1461.

- It is possible to enter codes by using bar code scanner.

2.11.6 Label Format Key Table (Menu code 1470)

(MENU → 4. Store Data Table → 7. Label Format Key Table)

There is a function to change label format and Barcode by using function key. This menu is used to set this function. You can use this function, after assigning empty key to that Function Key(83-90).

1. Label Speed Key

Enter the number 1-8 you want.



2. Label #.

Enter the label number to be assigned that function key.



3. PLU Barcode No.

Enter the barcode number to be assigned that function key.

2.12 Programming Global Setting

The Global Setting function is used to program functions of the CL5000 series like Label Format, Barcode Format, Discount and Tax settings that will be used on every PLU or transaction. These settings, when selected override any settings that are programmed in the PLU. This function can be very convenient and time saving when used properly.

2.12.1 Global Label Format (Menu code 1510)

(MENU → 5. Global Setting → 1. Label Format)

This Menu is used to select whether you use a Global Label Format for all PLU's or if the Label Format will be programmed in the PLU data structure.

Note: Label Formats 1~45 are Fixed Label Formats and can not be modified. Formats 51~99 are Free Formats that may be created using the CL-Works(PRO) PC Program and downloaded to the CL5000 series.

- ◆ You can press the SAVE key at anytime to save the current data and if you want to exit without saving, press the ESC key.

1. Global Label

- If you use Global Label, enter 1. If not, enter 0.
- Note: If you have selected to use a Global Label Format, the Label Format that is programmed in each PLU will be ignored and the Global Label Format selected in the next step will be used for every PLU.

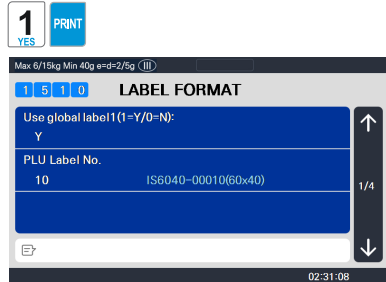

2. Set PLU label No.

- Set PLU label number

EX) PLU Label No. =2.IS6030-00002(60x30)

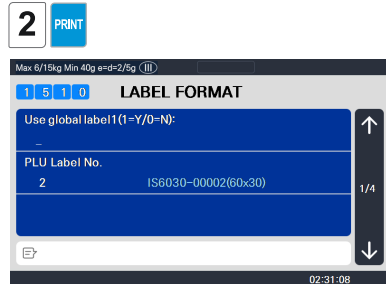

3. Set Miscellaneous label number

- Set label format for miscellaneous item.
- EX) Misc. Label No = 2.IS6030-00002(60x30)

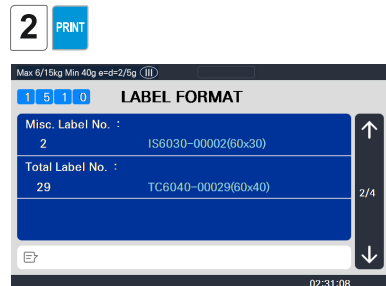

4. Set total label number

- Set label format of total label for Add-Up sales.

EX) Total label No. = 10 ,
IS6040-00010(60x40)



5. Set printing direction of total label

EX) Reverse Total Label = Y.



6. Set printing direction of PLU and Misc. item

EX) Reverse Item Label = Y



7. Input Label #2

EX) Label2 # : [11]



8. Input Ext. Label name

EX) Ext. Label name : [FORM1]

If you do not wish to use the label #2, simply input '0'. It operates in the same manner as the Aux.Label of the PLU input items. If the Aux.Label No. of PLU has already been registered, print with the corresponding label number, and if not, output the inputted Label #2

8. Exit menu

- If you want to exit, press ESC key.



2.12.2 Barcode Format (Menu code 1520)

(MENU → 5. Global Setting → 2. Barcode)

Global Barcode Setting provides all-in-one barcode setting by selecting nine different barcode options so that user does not need to save data for individual PLUs one by one. All related barcode data are selected and saved from PLU barcode data table user may already register.

◆ You can press the **SAVE** key at anytime to save the current data and if you want to exit without saving, press the **ESC** key.

1. Set Global Barcode

- If you use global barcode, enter 1. If not, enter 0.
- If you set it to 1, barcode number is ignored which is set in PLU programming

EX) Use global barcode



2. Set barcode number for by-weight PLU

EX) PLU Weight barcode No. = 2



3. Set barcode number for by-count PLU Misc. item

EX) PLU Count barcode No. = 2

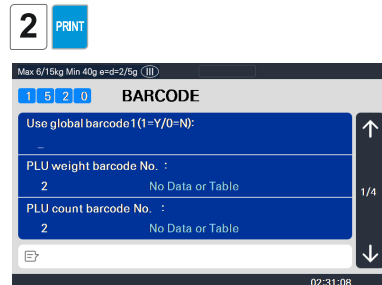

4. Set barcode number for by-PCS PLU

EX) PLU PCS barcode No. = 2

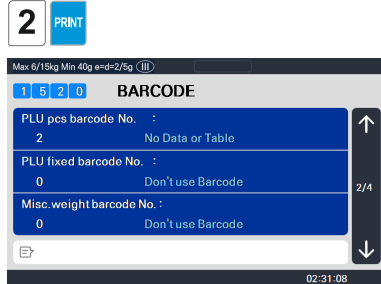

5. Set barcode number for fixed PLU

EX) PLU fixed barcode No. = 2



6. Set barcode number for Misc. weight item

EX) Misc. weight barcode No. = 2



7. Set barcode number for Misc. count item

EX) Misc. Count barcode No. = 2

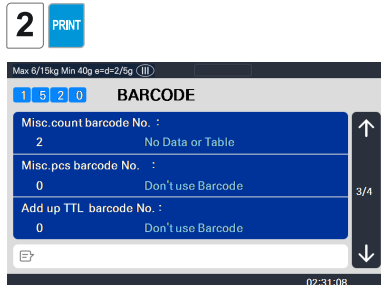

8. Set barcode number for Misc. PCS item

EX) Misc. PCS barcode No. = 2



9. Set barcode number for Add-Up Total

EX) Add Up TTL barcode No. = 2

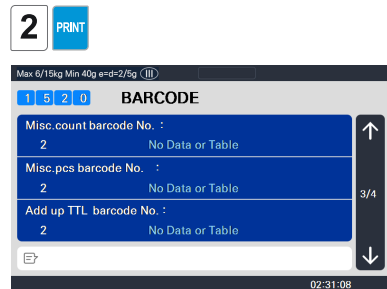

10. Set barcode number for Add-Up Total2

EX) Add Up TTL barcode2 No. = 2



11. Set barcode2 number

EX) PLU Weight barcode No. = 2

Note: Barcode 2 will be printed only if it is a label with barcode 2 field.

If you do not wish to use barcode2, you simply enter '0'. It operates in the same manner as the Barcode2 No. of the PLU input items. If the Barcode2 No. of PLU has already been registered, then, it prints the corresponding barcode, and if there is no inputted number, then, barcode of the number inputted here will be outputted.

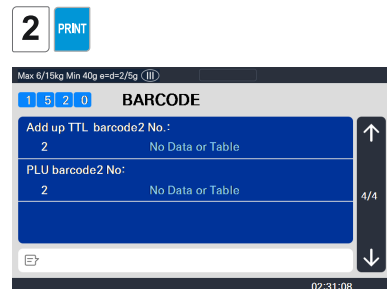

12. Exit menu

- If you want to exit, press ESC key.



2.12.3 Tax (Menu code 1540)

(MENU → 5. Global Setting → 4. Tax)

This menu is to set up function about Global Tax.

2.12.3.1 Set Global Tax (Menu code 1541)

(MENU → 5. Global Setting → 4. Tax → 1. Set Global Tax)

1. Setting up Global Tax

It sets up the applied tax when product sales.

- 0 : Not use all Tax
- 1 : PLU tax only
- 2 : Global Tax only



2.12.3.2 Global Tax Number (Menu code 1542)

(MENU → 5. Global Setting → 4. Tax → 2. Global Tax No.)

1. Set up Select Tax No.

It sets up the kind of global tax when product sales.

- 0 : Don't Use TAX rate
 - 1 ~ 9 : Select registered tax
- (Selection among tax at registered menu 1230, 9 options)

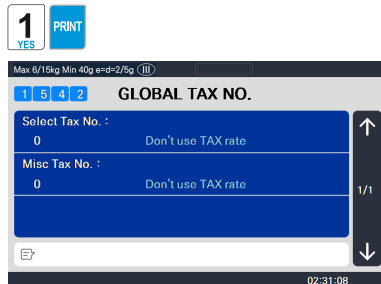

2. Set up Misc Tax No.

It sets up the kind of tax to apply to Misc by Weight, Misc by count, Misc by PCS.

- 0 : Don't Use MISC. tax
 - 1 ~ 9 : Select registered tax
- (Selection among tax at registered menu 1230, 9 options)

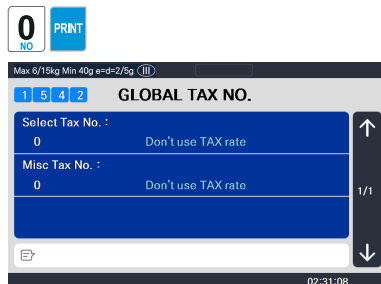

2.13 Printing Programming(Menu code 1700)

(MENU → 7. Print)

This chapter explains how to set printing-related environments, such as print label item, markdown, Hardware, serial number format, and ticket.

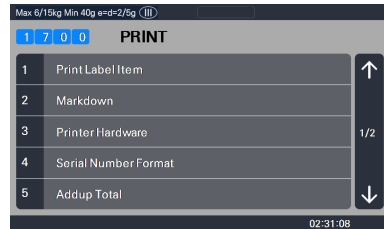

► PRINT Submenu

No	Submenus	Description
1	Print Label Item	Select item(s) which is(are) not printed on label.
2	Markdown	Select "Yes" or "No" to print both of original and discount information on the label.
3	Print Hardware	Set the label type and sensor of printer
4	Serial Number Format	Set the format of serial number to print label or ticket
5	ADD-UP Total	Select add-up total label whether is printed or not
6	Ticket	Set printing item for ticket

2.13.1 Print label item (Menu code 1710)

(MENU → 7. Print → 1. Print Label Item)

If you set any of the items to N, they will not be printed on any labels regardless of the label format.

You can use the **PG UP** and **PG DOWN** keys to navigate from page to page, or you can use the Arrow keys to go through each page 1 line at a time.

- ◆ You can press the **SAVE** key at anytime to save the current data and if you want to exit without saving, press the **ESC** key.

1. If you do not want to print, enter 0(N),
If you want to print, enter 1(Y).

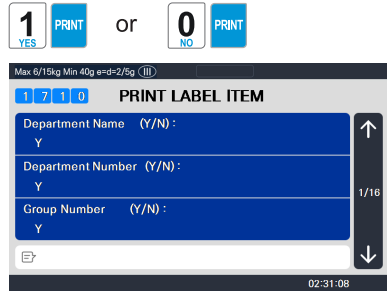

► Print Label Item

Page	Item	Page	Item
1	Department Name Department Number Group Number	9	Refer. Net Weight Refer. Gross Weight Percent Tare
2	PLU Number PLU Name 1 PLU Name 2	10	Percent Tare Limit Saved Price Label Serial
3	PLU Name 3 Item Code Unit Weight	11	Store Name Clerk Number Clerk Name
4	Tax Rate Tax Price Tare Weight	12	Customer Name Customer Number Scale Number
5	Pieces Unit Symbol Sell By Date	13	Day of Week Currency Rate Second Total Price
6	Sell By Time Packed On Date Packed On Time	14	Second Unit Price Traceability Nutrition Fact
7	Produced Date Cook By Date Bonus Point	15	Label Caption Total Tax Price Second Add Total
8	Origin Ingredient Sales Message	16	Barcodes Image

2.13.2 Markdown (Menu code 1720)

(MENU → 7. Print → 2. Mark down)

The Markdown Menu is used to determine if both the original and discounted unit price, total price, weight or quantity information is printed on the label. There are 4 sub- menus available.

► Markdown Sub-menu

No	Sub-menu	Description
1	Total Price Markdown	Select "Yes" to display both of original total price and the discounted total price if any. Otherwise, select No .
2	Unit Price Markdown	Select "Yes" to display both of original unit price and the discounted unit price if any. Otherwise, select No .
3	Weight Markdown	Select "Yes" to display both of original weight and the discounted weight if any. Otherwise, select No .
4	Quantity Markdown	Select "Yes" to display both of original quantity and the discounted quantity if any. Otherwise, select No .

1. Select Yes or No by using 1 or 0 key and press

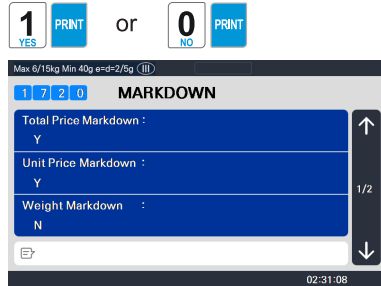

2. After setting all of above MARK DOWN sub-menus use "X/ESC" key or "SAVE" key to go back to PRINT Main menu.



2.13.3 Printer Hardware (Menu code 1730)

(MENU → 7. Print → 3. Printer Hardware)

This section is to explain how to set printing H/W environments in the following table.

1. Press “3” to get into H/W setting mode on Print Menu.

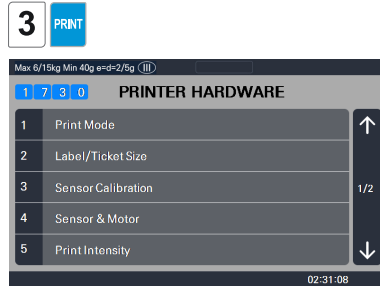

► Printer Hardware Sub-Menu

No.	Sub-menu	Description
1	Print Mode	Select label, ticket or continuous label mode.
2	Label / Ticket Size	If it is Label mode, “Width(60)”, “Height(40)” and “Gap length(2)” size is set, If it is Ticket mode, “Width(60)”, “Feed(20)” and “End Margin(30)” size is set. If you use Continuous Label Paper in Label mode, “Gap length” value is applied to “End Margin”. * The values in () are default.
3	Sensor Calibration	Enter the “Gap(128)” and “Peel(128)” values for printing sensor calibration. * The values in () are default. * If you press “TEST” key, Gap and Peel values are adjusted automatically. * In case of Ticket mode, Gap value is not saved.
4	Sensor & Motor	Set Peel-off sensor, Rewind Motor and Label Paper type
5	Print Intensity	Set the extent of intensity of label (ticket) printed.
6	Adjust Feed Length	Set adjusting values of feed length. This value can be from -200 to +200. You can change sign(+, -) by pressing ZERO key. + value will print higher than THP. * Pressing “TEST” key automatically feeds to adjust the feed length.
7	Label Preprint	You can set preprint length.
8	Adjust Reverse Feed Length	Set adjusting values of reverse feed length. This value can be from 0 to 400. You can change.

2.13.3.1 Print Mode (Menu code 1731)

(MENU → 7. Print → 3. Printer Hardware → 1. Print Mode)

Select "0" for Label Mode, "1" for Ticket Mode or "2" for Continuous Label Mode.

- Press "PRINT" to save.

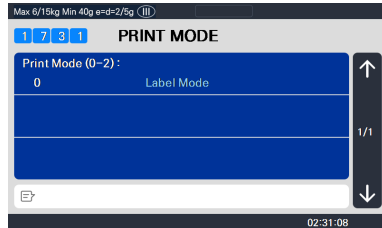

2.13.3.2 Label Size/Ticket Size (Menu code 1732)

(MENU → 7. Print → 3. Printer Hardware → 2. Label Size)

Enter values for "Width", "Height", "Gap Length", "Feed" and "End Margin".
If you press "TEST" key, height and gap length of current label is measured.

- If it is Ticket Mode, "TICKET SIZE" is displayed, and "TEST" key is not operated. And "Feed", "End Margin" instead of "Height", "Gap Length" shows up.
- If it is Continuous Label Mode, "CONT. LABEL SIZE" is displayed, and "TEST" key is not operated. And "End Margin" instead of "Gap Length" shows up.



2.13.3.3 Sensor Calibration (Menu code 1733)

(MENU → 7. Print → 3. Printer Hardware → 3. Sensor Calibration)

Enter appropriate values for "Gap", "Peel", and "Out of Paper".

- If you press "TEST" key, Gap and Peel values are adjusted automatically.
- If it is Ticket mode, "Gap" value is not saved.

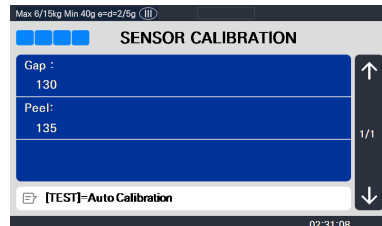

2.13.3.4 Sensor & Motor (Menu code 1734)

(MENU → 7. Print → 3. Printer Hardware → 4. Sensor & Motor)

Enter appropriate values or “Yes” or “No” for “Active peel-off”, “Active rewind motor”, “Label paper”, and “Active Headup sensor”.

- If there is no gap on a label, set Label Paper to 0, if there a gap, set it to 1.
- When “Ticket Mode” is in “Print Mode”, [Peel-off] [Rewind Motor] and [Label Paper] do not work.

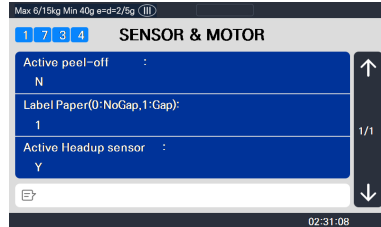

2.13.3.5 Print Intensity (Menu code 1735)

(MENU → 7. Print → 3. Printer Hardware → 5. Print Intensity)

Enter any value from “0” to “20”.
Press “TEST” to test printing a label.

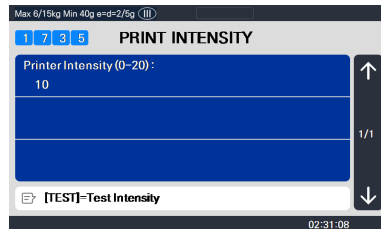

2.13.3.6 Adjust Feed Length (Menu code 1736)

(MENU → 7. Print → 3. Printer Hardware → 6. Adjust Feed Length)

Enter any value of the feed alignment from “-200” to “+200”.
Press “ZERO” to toggle sign.
Press “TEST” to test feed or “ENTER” to save current “FEED” Length value.

- 1pixel = 0.125mm

Ex) “+80” will print 10mm higher.
Ex) “-40” will print 5mm lower.

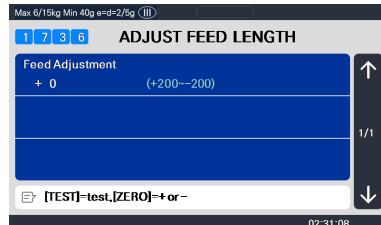

2.13.3.7 Label Preprint (Menu code 1737)

(MENU → 7. Print → 3. Printer Hardware → 7. Label Preprint)

Enter "Y(Yes)" or "N(No)" to select Preprint mode and any value of the preprint length from "0 mm" to "10 mm".

Press "TEST" to test preprinting.

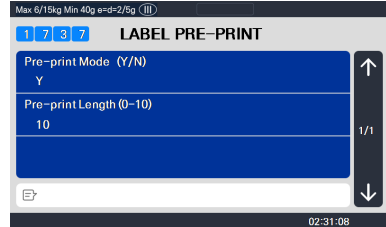

After setting all of above H/W setting submenus use "X/ESC" key to go back to PRINT main menu



2.13.3.8 Adjust Reverse Feed Length (Menu code 1738)

(MENU → 7. Print → 3. Printer Hardware → 8. Adjust Reverse Feed Length)

Enter any value of the reverse feed alignment from "0" to "400".

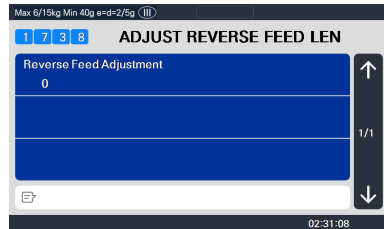

After setting all of above H/W setting submenus use "X/ESC" key to go back to PRINT main menu



2.13.4 Serial Number Format (Menu code 1740)

(MENU → 7. Print → 4. Serial Number Format)

SERIAL NUMBER FORMAT programming is for numbering of label/ticket issued (printed) on label/ticket. User may identify daily total counts of label/ticket used up.

- ① Press "4" to go to SERIAL NUMBER FORMAT menu in PRINT main menu.

4

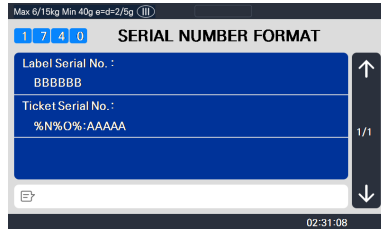

- ② Enter appropriate data in [].

EX) #0001 on label

EX) RCT#001 on ticket

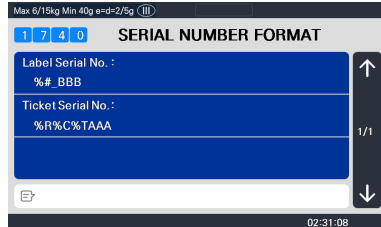

Meaning

- I : Item Code
- N : PLU Number
- P : Price
- U : Unit Price
- W : Weight
- Q : Quantity
- D : Department
- G : group
- A : Ticket Counter (Ticket Mode)
- B : Scale Transaction Counter
- F : PLU Prefix Character
- T : Text Character
- R : Transaction Counter of Each PLU
- L : Clerk Number
- % : Print Fixed Character in the Next Space.
- K : Country Code (For Future)

2.13.5 Add-Up Total (Menu code 1750)

(MENU → 7. Print → 5. Add-up Total)

This section shows how to set printing environments of total label and item label when you use ADD-UP sales.

- Press "5" to get into ADD-UP TOTAL menu in PRINT main menu.

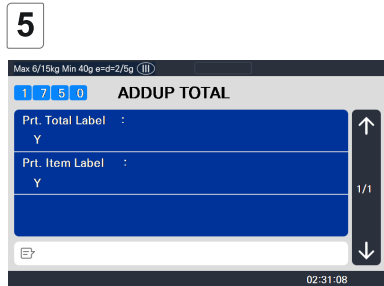

- Press "0" for "No" or "1" for "Yes" in [].

EX) Print Total Label?? - Yes
Print Item Label?? - No

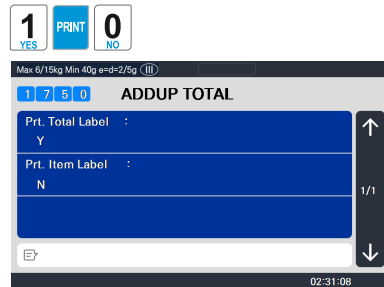

- Press "PRINT" key to save and go back to PRINT main menu



► Add-up setting

ADD-UP Setting	Description
Print Total Label	Total label is printed when you press the PRINT key during add-up sales.
Print Item Label	Item label is printed whenever you press the ADD key.

※ It is applied to Label mode.

2.13.6 Ticket (Menu code 1760)

(MENU → 7. Print → 6. Ticket)

This section shows how to select item(s) (Contents) printed on ticket.

① Press “6” to go to TICKET setting.

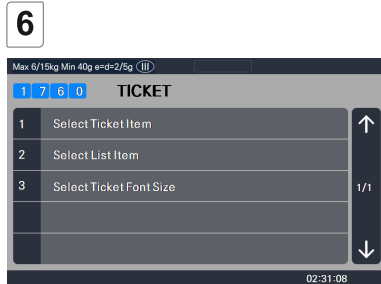

2.13.6.1 Select Ticket Item (Menu code 1761)

(MENU → 7. Print → 6. Ticket → 1. Select Ticket Item)

① Press “1” to go to SELECT TICKET ITEM menu.

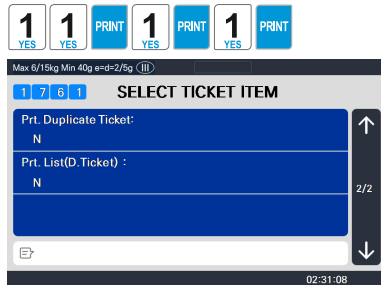

2.13.6.2 Select List Item (Menu code 1762)

(MENU → 7. Print → 6. Ticket → 2. Select List Item)

Before setting list item, you have to set “Print List” to “Y” in menu 1761.

① Press “2” to get into SELECT LIST ITEM menu.
 Select “Yes” or “No” for “Print Store Name”, “Print Clerk Name”, “Print Item Barcode”, “Tax Information”, and “Print Traceability”.

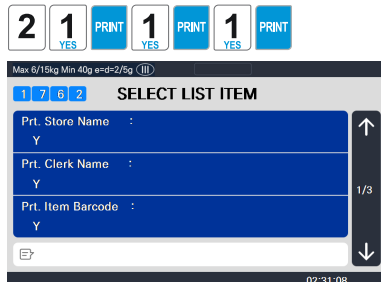

- ② And, select appropriate ID # for "Ticket Head Form" and "Ticket Tail Form".

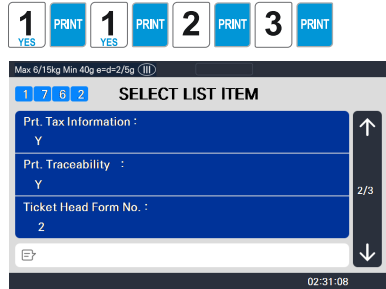

- ③ Enter message text for "Ticket Head" and "Ticket Tail".

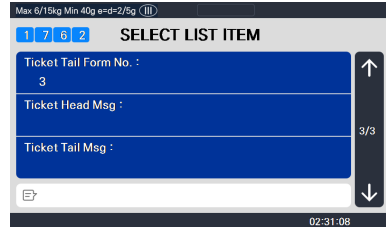

► Ticket Format Setting

	Ticket Format Setting	Description
Ticket Item	Prt. List (Y/N)	It outputs product list (Detailed item can be set in the following menu, 1762) ■ Printing the list of each sales item(s). * In case of "Yes" selected user can go to "List Item" setting.
	Prt. Total Barcode	It outputs the TTL barcode set at the global barcode ■ Printing total barcode on ticket.
	Prt. Total Label	It outputs the Total label set at the global label format. ■ Printing total amount on ticket.
	Prt. duplicate ticket	All ticket sections with exclusion of the product list are outputted once more. ■ Printing duplication of ticket
	Prt. List (D. ticket)	Same ticket including the product list is issued twice (Print Duplicate Ticket must be set at 'Y' for it to be usable) ■ Printing List of items on duplicated ticket Note : N=Printing amount of only total price for duplicate ticket
List Item	Prt. Store Name	■ Printing store name on ticket.
	Prt. Clerk Name	■ Printing clerk name on ticket.
	Prt. Item Barcode	■ Printing every item s barcode on ticket.
	Prt. Tax Information	■ Printing tax information on ticket.
	Prt. Traceability	■ Printing traceability information on ticket
	Ticket Head Form No.	■ Printing label format No. for ticket head.
	Ticket Tail Form No.	■ Printing label format No. for ticket tail.
	Ticket Head Message	■ Printing message for ticket head.
Ticket Tail Message	■ Printing message for ticket tail.	

※ You have to download label format for Ticket Head Form No. and Ticket Tail Form No. from PC.

2.13.6.3 Select Ticket Font Size (Menu code 1763)

(MENU → 7. Print → 6. Ticket → 3. Select Ticket Font Size)

It can designate the size of the letters of the item that is printed in the ticket.

▶ Ticket Font Size Setting

Ticket Font Setting	Description
PLU Name	■ Adjust size of product number name
Transaction Data	■ Adjust size of price of unit price weight unit product
Total Value	■ Adjust the size of total price
Ticket Serial No.	■ Adjust the size of ticket issuance number

It can designate from 0 to 3.

※ Size of Subtotal, Tax information, Payment and Print Label cannot be adjusted

2.14 Programming Scale Configuration (Menu code 1800)

(MENU → 8. Scale Config)

This chapter explains how to configure the scale. The main menu of Scale Configuration is shown as below.

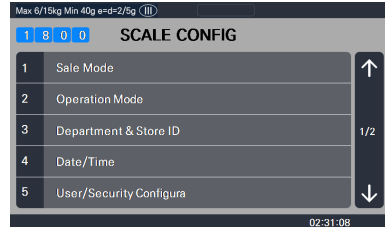

2.14.1 Sale Mode (Menu code 1810)

(MENU → 8. Scale Config → 1. Scale Mode)

This section is to select sale mode, which have seven different modes in the following table.

► Sale Modes

No.	Sale Modes	Description
1	REG: Ticket & Floating	Selecting Ticket and Floating Clerk Mode.
2	REG: Label	Selecting Label Mode.
3	REG: Prepack	Selecting Prepack Mode.
4	REG: Label & Floating	Selecting Label and Floating Clerk Mode.
5	Manager	Selecting Manager Mode
6	Repack	Selecting Repack Mode (In this mode, report is not updated.)
7	Self Service & Label	Selecting Self Service Mode (In this mode, you can use speed key and some keys. If you want to finish this mode, while pressing MENU key, enter system password and PRINT key)

- ▶ Selecting one of following sale modes, user may select an one-stop setting for Clerk, Operation, Print, and Prepack mode.

MODE	Clerk Mode	Operation Mode	Print Mode	Prepack Mode
1. REG: Ticket & Floating	Floating Clerk	Regist	Ticket	OFF
2. REG: Label	No Clerk	Regist	Label	OFF
3. REG: Prepack	No Clerk	Regist	Label	ON
4. REG: Label & Floating	Floating Clerk	Regist	Label	OFF
5. Manager	-	Manager	-	OFF
6. Repack	-	Repack	-	OFF
7. Self Service & Label	-	-	Label	OFF

Usually user has to set each option you wish to for clerk, operation, print or prepack mode. However, user may select simply one-stop sales mode for 7 different modes-Clerk, Operation, Print, and Prepack mode. User may also set options for Clerk/Operation mode in MENU 1820 and Print/Prepack mode in MENU 1731.

1. Select a sale mode

EX) Sale mode = 2.REG: Label

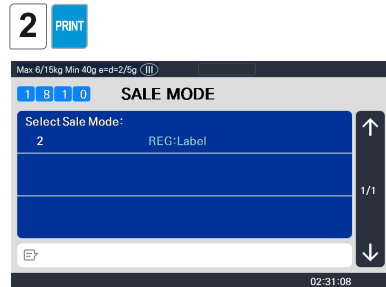

2. Select "Floating & Ticket" mode

EX) Sale mode = 1.REG: Ticket & Floating

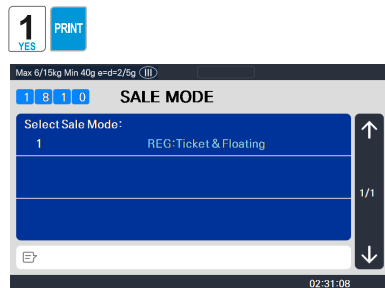

2.14.2 Operation Mode (Menu code 1820)

(MENU → 8. Scale Config → 2. Operation Mode)

This section is to select a clerk and operation mode. There are three different operation modes, REGISTRATION, RE-PACK, MANAGER and three different clerk modes, NO CLERK, STANDARD CLERK, and FLOATING CLERK.

1. Select appropriate "CLERK MODE" and "OPERATION MODE".

EX) Clerk Mode=Standard Clerk
Operation mode = Regist

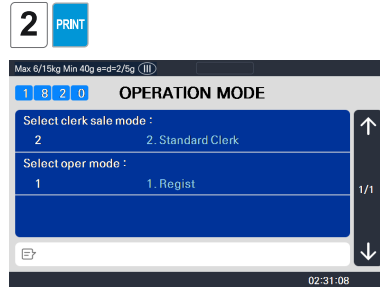

EX) Operation mode=Registration



► Clerk Modes

No	Clerk Modes	Description
1	No Clerk	Sales clerk do not log in and makes sales using PRINT key.
2	Standard Clerk	Sales clerk can make sales when he/she logs in.
3	Floating Clerk	Plural sales clerks can make sales using own clerk ID.

► Operation Modes

No	Operation Modes	Description
1	Regist	Normal sales mode.
2	Repack	Normal sales mode but not included in total sales data(report). Good for clerk training.
3	Manager	In this mode user can access all of functions without any permission.

2.14.3 Department & Store ID (Menu code 1830)

(MENU → 8. Scale Config → 3. Department & Store ID)

This section shows how to select current department where scale is being used. User can use (call up) PLUs only for current department selected in sales mode. For example, if current department selected is GROCERY user can call up items registered only in GROCERY department. If user would like to use PLUs registered in other department than current department he/she should change scale s department setting. Store No. represents Store Name (or branch number) on label/ticket printed.

1. Select "DEPARTMENT No." and "STORE ID".

EX) DEPARTMENT No.= 2 (Grocery)



Store No.= 1 (Branch #1)



2.14.4 Date / Time (Menu code 1840)

(MENU → 8. Scale Config → 4. Date/Time)

This section is to set scale s DATE / TIME appropriately.

1. Set appropriate "DATE", "TIME", and "MONTH FORMAT".

EX) DATE= [07.02.04]
 TIME= [10:30:00]
 Month Format= [0]

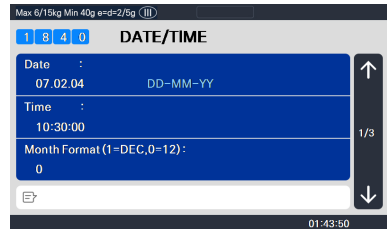

2. Set "YEAR FORMAT", TIME FORMAT and separator for "DATE".

EX) Year Format (0=2001, 1=01) = [1]
 Time Format(0=24, 1=12) = [0]
 Date Separator = [-]

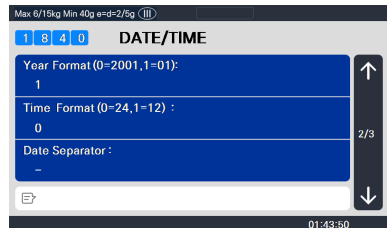

3. Set separators for "TIME", using ASCII code table on page

EX) Time Separator = [:]

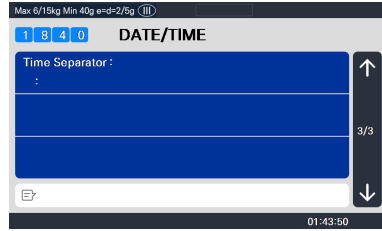

Please refer to "ASCII Code Table" (chapter 4.4) to input special characters in Date or Time separator.

4. Press "PRINT" key to save it and go out to SCALE CONFIGURATION main menu.



2.14.5 User/ Security Configuration (Menu code 1850)

(MENU → 8. Scale Config → 5. User/Security Configuration)

This section is to create, edit, change, list, delete clerk's security information and configure security level.

2.14.5.1 New/Edit User(Menu code 1851)

(MENU → 8. Scale Config → 5. User/Security Con → 1. New/Edit)

Enter appropriate USER data for CLERK number, CLERK NAME, NICKNAME, CLERK PASSWORD, CLERK LEVEL, and Use For Training.

EX) CLERK No.=[2],
 CLERK NAME =[CHRISTOPER]
 NICKNAME =[CHRIS],
 CLERK PASSWORD =[0115],
 CLERK LEVEL =[3],
 USE FOR TRAINING = [N]

Note: If you use floating mode, you have to register all clerks.

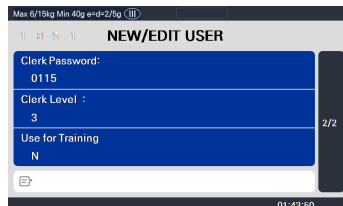
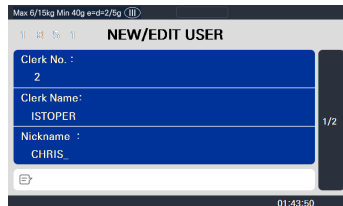

► NEW/EDIT USER in USER'S Security Condition

No	Operation Modes	Description
1	Clerk No.	This value can be from 1 to 95.
2	Clerk Name	This value is available up to 22 characters.
3	Nickname	This value is available up to 7 characters. It can be printed on a label and displayed on the scale.
4	Clerk Password	4 digit (alphanumeric)
5	Clerk Level	0~3 level
6	Use for Training	Use Training account

Password: When you enter the password, you have to type clerk number(2digit) and password(4 digit). For example, if your clerk number is 20 and password is 1234, you have to type 201234. Minimum password is 3 digit and maximum password is 6 digit.

If there is no level 3 clerk, you can use default value. (Clerk No:1, password:1, Level:3) Therefore default password is 011.

- You have to set a level 3 clerk. If there is no level 3 clerk, you can use default password(011) and if any, you cannot use it.

Clerk level: This value can be from 0 to 3. This level is related to menu 1855(Config permission). If clerk 2 is set to level 2, this clerk can use the function which is set to level 1, 2 in menu 1855 and cannot use the function which is set to level 3.

No.	Level	Description
1	0	It is assigned to employees who is registered but do not use scale.
2	1	Lowest level. Normal employees are assigned to level 1.
3	2	It is proper for chief clerk.
4	3	Highest level. It is proper for store manager.

2.14.5.2 Change Password (Menu code 1852)

(MENU → 8. Scale Config → 5. User/Security Con → 2. Change Password)

1. Enter password.

- Clerk No. (2 digit) + password (4 digit)

EX) CLERK No.=1 , PASSWORD =2 → 012

CLERK No.=11 , PASSWORD =22 → 1122

CLERK No.=36 , PASSWORD =1234 → 361234



2. New Password

- Enter new password

EX) CLERK ID =1, PASSWORD = 22

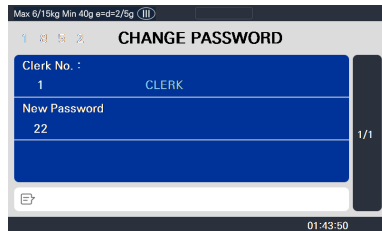

2.14.5.3 List User (Menu code 1853)

(MENU → 8. SCALE CONFIG → 5. User/Security Con. → 3. List)

1. Enter start number and end number to check

- To list all, press the SAVE key

EX) 1~10

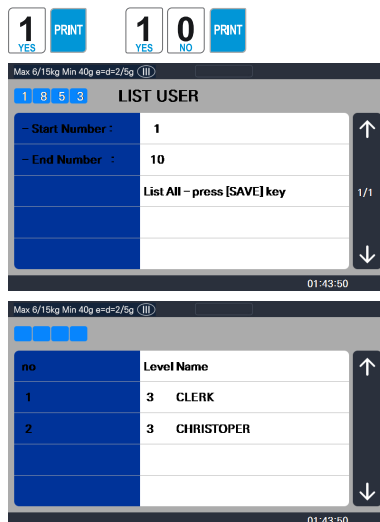

2.14.5.4 Delete User (Menu code 1854)

(MENU → 8. SCALE CONFIG → 5. User/Security Con. → 4. Delete)

1. Enter clerk number to delete

EX) Delete clerk no. 1

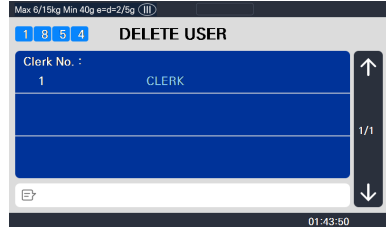

2.14.5.5 Config Permission (Menu code 1855)

(MENU → 8. SCALE CONFIG → 5. User/Security Con. → 5. Config Permission)

Permission level is related to clerk level and if the clerk level is lower than permission level, this clerk cannot access that function. Refer to clerk level on chapter 2.14.5.1

※ If permission level is "0", all clerks can access this function.

EX) If you set permission level to 2 for price change key and clerk 1 is set to level 1 and clerk 2 is set to level 2, clerk 1 can not use this key but clerk 2 can use this key

► Setting Configuration Permission

No	Display	Description
1	Use Item Change Key	Set a Permission level for PLU Change Key. (You can define this function key in menu 1881 on chapter 2.14.8.1)
2	Use Price Change Key	Set a Permission level for price change Key.
3	Use Dept. Change Key	Set a Permission level for department Change Key.
4	Use Pay Key	Set a Permission level for Pay Key.
5	Use Date Change Key	Set a Permission level for data Change Key.
6	Use Type Change Key	Set a Permission level for PLU type Change Key.
7	Use Selection PLU Item	Set a Permission level for Selecting PLU item.
8	Use Input Weight Key	Set a Permission level for In-weight key.
9	Use Edit Discount Key	Set a Permission level for discount.
10	Allow Clerk Sale	Set a permission level for password in floating mode
11	Allow Void	Set a permission level to void item
12	Allow ADD-UP	Set a permission level for add-up sales
13	Allow Return	Set a permission level to return item

14	Allow Override	Set a permission level to override price
15	Allow Cash Drawer Open	Set a permission level to open cash drawer
16	Allow Menu	Set a permission level to go to program menu
17	Allow menu for edit PLU	Set a permission level to edit PLU
18	Allow Price Change	Set a permission level to change price
19	Allow Global Set	Set a permission level for global setting
20	Allow X Report	Set a permission level for X report
21	Allow Z Report	Set a permission level for Z report
22	Allow Store Data Edit	Set a permission level to edit store data
23	Allow Tax Edit	Set a permission level to edit tax
24	Allow Scale Config	Set a permission level for scale configuration
25	Allow Edit Table 1	Set a permission level to edit data table 1.
26	Allow Edit Table 2	Set a permission level to edit data table 2.
27	Allow Printer Setting	Set a permission level for printer setting
28	Allow Change Oper. Mode	Set a permission level to change operation mode
29	Allow Change User Param	Set a permission level to change user parameter
30	Allow Set Communication	Set a permission level for communication setting
31	Use Save Key	Set a permission level for Save Key
32	Allow Reopen Sale	Set a permission level for reopen sale

You can use the **PG UP** and **PG DOWN** keys to navigate from page to page, or you can use the Arrow keys to go through each page 1 line at a time.

2.14.5.6 Clerk Key (Menu code 1856)

(MENU → 8. SCALE CONFIG → 5. User/Security Con. → 6. Clerk Key)

You can assign Clerk key to clerk. There are 64 Clerk keys and you have to set these keys in menu 1880 (Key define). See chapter 2.14.8.

1. Enter Clerk Key

- This value can be from 1 to 64.

EX) Clerk Key No. = 1

2. Enter Clerk No.

EX) Clerk = 1 CLERK



For example if you set "A" key to clerk 2 in menu 1881 (Key define), and call up a PLU and press "A" key in floating sale mode, it is recognized that clerk no. 2 (LEE) sold this item.

2.14.6 Test (Menu code 1860)

(MENU → 8. SCALE CONFIG → 6. Test)

This programming is to test the scale by itself in the 8 fields , such as DISPLAY , A/D, KEYBOARD , CHESS PRINTER, PRINTER SENSOR, MEMORY INFORMATION(*), FIRMWARE VERSION and COMMUNICATION.

① Press “6” to get into TEST menu.

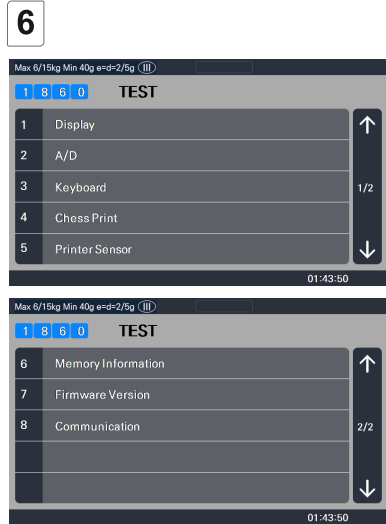

2.14.6.1 Display Test (Menu code 1861)

(MENU → 8. SCALE CONFIG → 6. Test → 1. Display)

To test the display, press “1” on Test menu screen. It automatically tests it. You can exit from testing, by pressing “X/ESC” key.

Note : G-type only shows Chess Print Screen

2.14.6.2 A/D Test (Menu code 1862)

(MENU → 8. SCALE CONFIG → 6. Test → 2. A/D)

To test the A/D, press “2”
 To set zero press “ZERO”
 User may exit from this menu, using “X/ESC” key

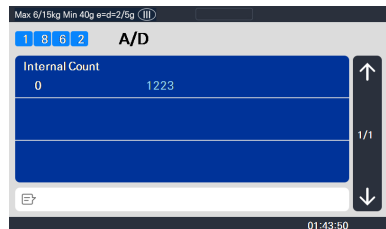

2.14.6.3 Keyboard Test (Menu code 1863)

(MENU → 8. SCALE CONFIG → 6. Test → 3. Keyboard)

To test keyboard, press “3” Display will show grid point Press any key to test key pad.
To exit keyboard test, press “ESC” two times.

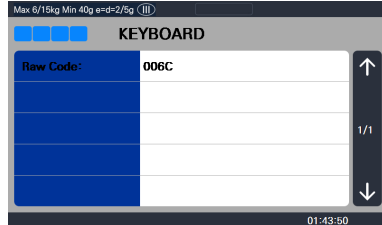

2.14.6.4 Chess Printer Test (Menu code 1864)

(MENU → 8. SCALE CONFIG → 6. Test → 4. Chess Print)

Press “TEST” key to test printing a label.

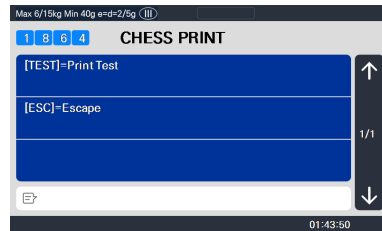

2.14.6.5 Printer Sensor Test (Menu code 1865)

(MENU → 8. SCALE CONFIG → 6. Test → 5. Printer Sensor)

To test printer sensor, press “5” on Test menu screen. The scale shows the conditions of current printer.

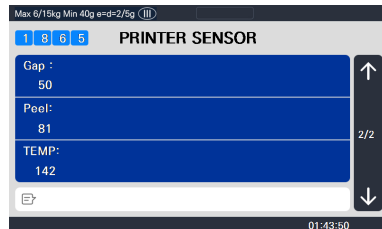
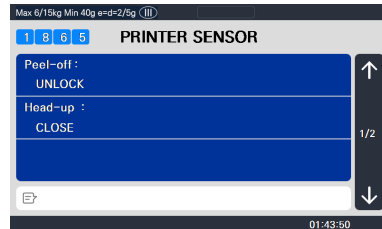

► Printer Sensor Test Items

No	Test Items	Description
1	Peel-off	To test that peel-off sensor is properly work.
2	Head-up	To test that TPH is opened or not
3	Gap	To show real time Gap sensor's value.
4	Peel	To show real time peel off sensor's value.

2.14.6.6 Memory Information (Menu code 1866)

(MENU → 8. SCALE CONFIG → 6. Test → 6. Memory Information)

To see memory information, press “6” on Test menu screen. The display shows current memory size. 0 indicates 1MB. You can exit from this menu, by pressing

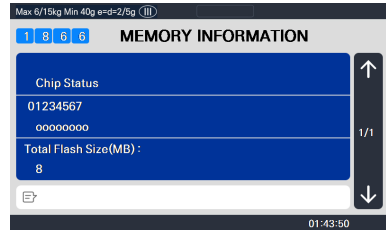

2.14.6.7 Firmware Version (Menu code 1867)

(MENU → 8. SCALE CONFIG → 6. Test → 7. Firmware Version)

You can check firmware version of the scale.

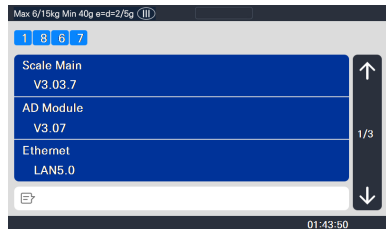

2.14.6.8 Communication (Menu code 1868)

(MENU → 8. SCALE CONFIG → 6. Test → 8. Communication)

2.14.7 Scale Parameter (Menu code 1870)

(MENU → 8. SCALE CONFIG → 7. Scale Parameter)

You can set scale's environment as below.

► Scale Parameter

Menu	Sub-menu	Setting Value	Description
1. Printing (Menu code:1872)	Label prt w,o rewind(x Key)	Y/N	Do not use rewind function when you use "X" key.
	Confirm prt report on label	0:Print automatically 1:Need to confirm to print report and do not confirm any more until power off 2:Need to confirm to print report and do not confirm any more until you exit program mode	Set confrim method when you print report in label mode
	Print origin for comm.,line	0: Do not print 1: Print in Name 1 2: Print in Name 2 3: Print in Name 3	Print origin in commodity line.
	Print unit symbol in qty area	Y/N	Print Qty Symbol in qty area.
	Print pieces in unit price area	Y/N	Print Pieces in unit price area.
	Print All report within range	Y/N	Print all report
	Swedish auto barcode	0:Not use 1:Price Auto Code 2:Weight Auto Code	Selection the way and whether using Swedish automatic bar code function
	Print pack type	0:Not use 1:alphabet 2:day(Mon, Tue,...) 3:day,year	Setting up the type when packing date is printed
	Print Item when return	0:Do not print 1: Print	Print return list when it returns.

Menu	Sub-menu	Setting Value	Description
2. Sale Setup (Menu code:1873)	Save unit price change	Y/N	Save unit price change.
	Save Type change	Y/N	Save type Change in PLU
	Start save mode (start up)	Y/N	Save mode is active when you turn on the scale.
	PLU clr Aft sale(WT. On Tray)	Y/N	Plu is cleared after printing even though there is an item on the platter.
	Print count w,o misc. key	Y/N	If you enter count, it is considered that misc. Count condition when there is no Misc. Key
	Print weight w,o misc. key	Y/N	If there is an item on the platter, it is considered that misc. weight condition when there is no Misc. Key
	T.price = price + Tax	Y/N	Tax is included in total price
	Shift key instead return Key	Y/N	Use shift key instead of return key.
	Use double speed key	Y/N	Use double speed key
	Use double DATE/TIME key	Y/N	If you double-click, command window will be appear
	Multi-print on discount sale	Y/N	Setting up to print discounted product label repeatedly
	Start auto mede(start up)	Y/N	Setting up to select whether it start with Auto Mode when it boots.
Enable Quick PLU	Y/N	Once you press the number key, PLU is called immediately.	
3. Clerk Logout (Menu code:1874)	Log off after transaction	Y/N	After printing label, automatically Clerk Log off
	Clerk log out Time(0.1s)	1~99	Set clerk log out time.

You can use the **PG UP** and **PG DOWN** keys to navigate from page to page, or you can use the Arrow keys to go through each page 1 line at a time.

2.14.7.1 Backup to USB Memory (Menu code 1877)

(MENU → 8. SCALE CONFIG → 7. Scale Parameter → 7. Backup to USB Memory)

After connecting to USB, Select Yes or No by using “1” or “0” key.
 If you press “1” key in “Backup to USB” menu, backup file(*.dat) going to be created in USB.
 If file already exists, data will be overwritten.

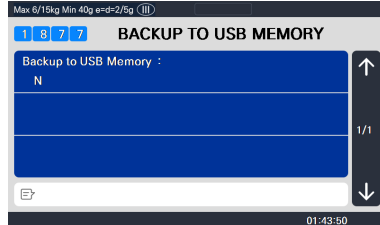

2.14.7.2 Restore from USB Memory (Menu code 1878)

(MENU → 8. SCALE CONFIG → 7. Scale Parameter → 8. Restore from USB Memory)

After connecting to USB, Select Yes or No by using “1” or “0” key.
 If you press “1” key in “Restore from USB” menu, Backup data(in USB) overwrite to scale data.
 After this process, Scale will be restarted.

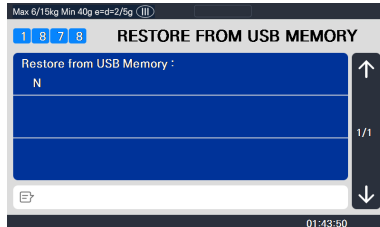

2.14.7.3 Scale Info (Menu code 1879)

(MENU → 8. SCALE CONFIG → 7. Scale Parameter → 9. Scale Info)

(1) Print Length of TPH

- Can count how long did TPH printed
- Can be reset in Menu (requires dealer password)

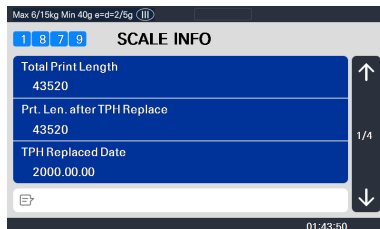

(2) Weight Overload Count

- Can count the number of overloads while scale is in operation
- Can be reset in CAL MODE. Weight times will be initialized simultaneously

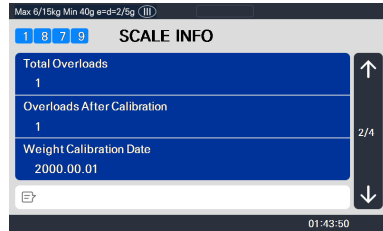

(3) Weighing Frequency Count

- Can count the number of times scale has been used to weigh objects
- Can be reset in CAL MODE. Number of overloads will be reset at the same time

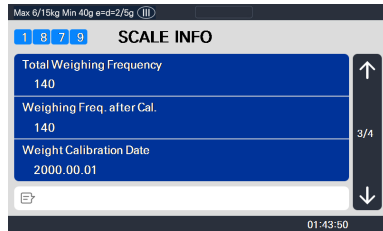

(4) Scale Operated Time

- Can count how long the scale was used in operation
- Can be reset in CAL MODE.

※ Two Counts exist in common

- Count based on production (factory)
- Count based on inspection date (reset)

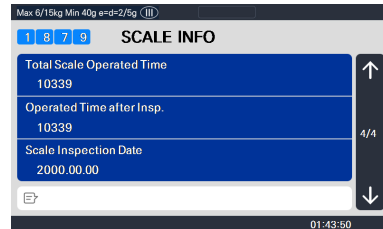

2.14.8 Function Key Define (Menu code 1880)

(MENU → 8. Scale → 8. function Key Define)

You can define function keys to Speed keys. It is recommended that you define function key to higher number Speed key because you can not use that PLU key.

2.14.8.1 Function Key Define (Menu code 1881)

1. Enter key code

Pole type : 72 Speed Keys

Standard type : 48 Speed Keys.

Double body type : 72 Speed Keys

If you press Speed key, the displays shows the key code of that speed key.

EX1) Standard Type :

EX1) Press last speed key.

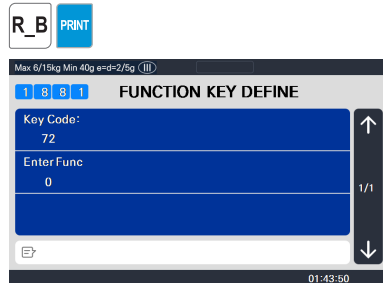

2. Enter function key

EX1) Use 12 Function key (Display Reset)

Refer to below table.

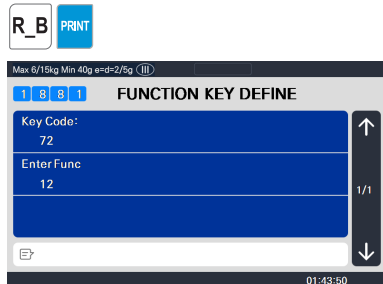

3. To cancel function key.

Enter key code to cancel and set Function Key No. to 0

EX) Key Code = 42

EX1) Function Key id = 0

If you cancel function key, you can use it as Speed key.

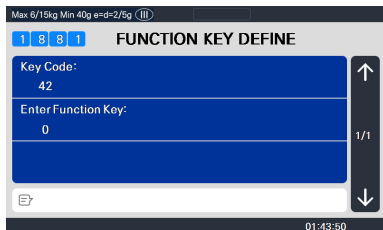

Cf. Double body type

F1~F4 default setting : Clerk 1 ~ Clerk 4

► Function Key.

Function Key	Define	Description
1	[DISC -]	- SALE Key
2	[DISC%]	% SALE Key
3	[SPECIAL SALE]	Special sales unit price
4	[NEGATIVE]	Negative sale
5	[FIXED PRICE]	Fixed Price Key
6	[TYPE CHANGE]	WT/CT Key
7	[CASHOPEN]	Cash Drawer Open Key
8	[GRAND TOTAL]	Grand Total Key
9	[PLU REFERENCE]	Reference PLU Key
10	[IN WEIGHT]	IN Weight Key
11	[LABEL/TICKET]	Toggle between the Label and Ticket
12	[DISPLAY RESET]	Display refresh
13	[MISC WEIGHT]	Misc. Weight Key
14	[MISC COUNT]	Misc. Count Key
15	[MISC PCS]	Misc. PCS Key
16	[EDIT SELL]	Sell By Date Change Key
17	[EDIT ORIGIN]	Origin Change Key.
18	[EDIT ITEM]	PLU Change Key
19	[EDIT DATETIME]	Change Date/Time
20	[EDIT D/C]	Set discount for current PLU
21	[EDIT SPEEDKEY]	Change PLU Speed key
22	[EDIT PRICE]	PLU Price Change Key
23	[CLERK CALL]	Clerk key to call indirectly
24	[LAST VOID]	Void Last Sale
25~28	[CURRENCY1~4]	Call Currency Table
29	[BATCH]	Batch Printing
31~39	[TARE KEY1~9]	Call Tare Table
40~42	[UNIT1~3]	Weight Unit Key kg : unit1=1kg, unit2=100g, unit3=N/A

		lb : unit1=1lb,unit2=1/2lb,unit3=1/4lb
43	[KGLB]	Toggle between the Kg and Lb
44	[PACKDATE]	Pack Date Change Key
45	[TICKET NO]	Edit Ticket Serial Number (Master scale) input range : 1~99999
50	[PRINTDATE]	Print Date On, Off
51~82	[CLERK(V1~V32)]	Clerk key
83~90	[LABEL1~8]	Label Change Key
91	[EDIT TAX]	Tax Change Key
92	[EDIT TRACE]	Traceability Change Key
93~124	[CLERK(V33~64)]	Clerk key
125	[SCAN CLERK]	Select the scan clerk
126	[BARCODE]	Input barcode number Key
127	[EDIT INGREDIENT]	Edit ingredient Key
128	[LARGE MSG CALL]	Large Message Call Key
129	[SALE SPECIAL]	Change Special Unit Price Key
138	[CUSTOMER NO]	Customer No. Input Key
139	[CUSTOMER CLOSE]	Customer No. close Key
140	[REOPEN]	Reopen Key
141~145	[DISC 10% ~ 50%]	10%~50% discount key
155	[RETURN]	Return key
169	[AUTO]	Auto, pre-pack key
170	[DATE/TIME]	Change display content of DATE/TIME area
171	[GLOBAL_TAX]	Apply Global TAX on current PLU temporary
172	[GLOBAL_LABEL]	Apply Global Label and Barcode(toggle)
173	[MULTI PRINT]	Print multiple label
181	[FEED]	Label feed key
182	[PREPACK]	Prepack key
183	[NETWEIGHT]	Prepack key
184	[ZERO]	Zero Setting
185	[TARE]	Tare Setting
186	[EDIT KEY]	Edit Speed Key Config

187	[SHIFT]	SHIFT Key
188	[CLEAR]	CLEAR Key
189	[PRINT]	PRINT Key
190	[PLU LIST]	show PLU list and call if it is pressed.
191	[LOCK SCREEN]	lock/unlock touch screen
192	[ADD]	ADD Key
207	[PLU]	Call PLU
208-218	[0]-[00]	number key 0, 1, 2, 3~ 00
219	[OVERRIDE]	Override key
220	[FOR]	For key
221	[VOID]	Void key
222	[PAY]	Pay key
223	[ST/TTL]	ST/TTL key
224	[PREV. PAGE]	Go to previous page
225	[NEXT PAGE]	Go to next page
226	[SELECT CAT.]	Select category
227	[COPY TICKET]	Copy ticket
228	[CHANGE PREFIX]	Change prefix
0 or 9999		PLU Key

2.14.8.2 Function Key Block (Menu code 1882)

(MENU → 8. SCALE CONFIG → 8. function Key Define → 2. Function Key Block)

You can block each function keys. (Chapter 1.6 KEY FUNTION)

1. Enter function key

Select the function key which you don't want to use. If you press function key, the display shows the key code of that function key.

EX1) Press "AUTO" key and "PRINT" key.

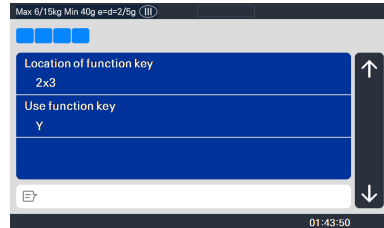

2. Select Yes or No

EX1) Select Yes or No by using "1" or "0" key.

2.15 Report

2.15.1 Introduction

X mode is used to read (i.e. print and display) sales data. There are variety of reports that you can generate from X mode. Each of these reports is kept in two separate counters or “books” called X1 and X2. The X1 and X2 reports allow you to print reports at any time for either of the reporting periods. You can use X1 reports to see current daily totals and X2 reports to see current weekly totals. The time period combination you chose is completely dependent upon how you use Z1 and Z2.

Remember that you can generate as many X reports as you would like because X mode does NOT clear any sales data.

2.15.2 Report Menu (Menu code 1600)

(MENU → 6. Report)

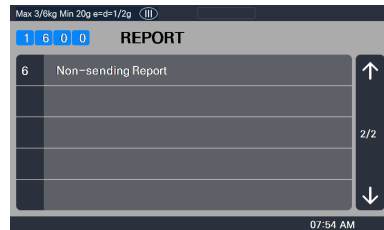

No.	Submenus	Description
1	X1 Report	Print and display sales data of period 1
2	Z1 Report	Print, display and clear sales data of period 1
3	X2 Report	Print and display sales data of period 2
4	Z2 Report	Print, display and clear sales data of period 2
5	Clear All	Clear all reports of period 1 and 2
6	Non-sending Report	Display and clear remained data

2.15.3 X1/X2 Report (Menu code 1610/1630)

(MENU → 6. Report → 1. X1 Report / → 3. X2 Report)

There are 7 detailed reports.

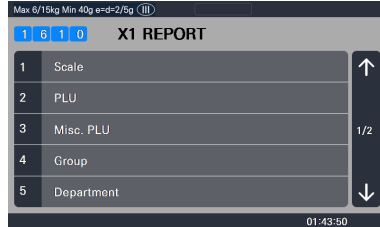

No	Submenus	Description
1	Scale	Print and display scale sales report
2	PLU	Print and display PLU sales report
3	Misc. PLU	Print and display Misc. PLU sales report
4	Group	Print and display group sales report
5	Department	Print and display department sales report
6	Hourly	Print and display hourly sales report
7	Clerk	Print and display clerk sales report

2.15.4 X1/X2 Scale Sales Report (Menu code 1611/1613)

(MENU → 6. Report → 1. X1 Report /3. X2. Report → 1. Scale)

If you press “ 1 ” key on X1/X2 Report menu screen, scale sales report is shown on the display.

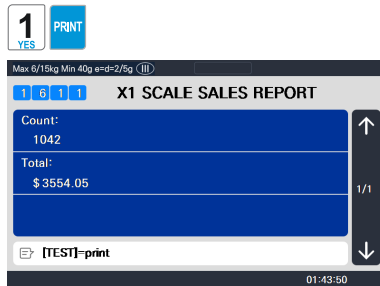

To print this report, press “ TEST ” key.

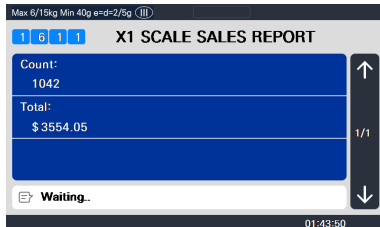

To exit this menu, press the “ESC” key.

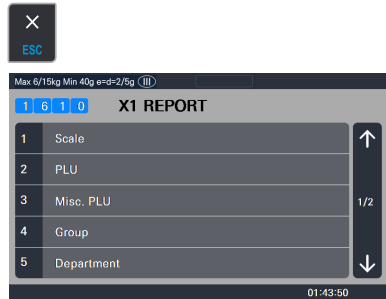

► Sample(Ticket) - Scale Report

```

X1 SCALE REPORT
AUG-23-04(MON) 09:46:36 AM
Last Reset
AUG-16-04(MON) 03:33:14 PM
=====
SCALE #01
-----
TOTAL COUNT          267
TOTAL PRICE          $ 5693.70
VOID COUNT           3
VOID PRICE           $ 27.30
REPACK COUNT         0
REPACK PRICE         $ 0.00
OVERRIDE COUNT       0
OVERRIDE PRICE       $ 0.00
DISCOUNT COUNT      0
DISCOUNT PRICE     $ 0.00
PREPACK COUNT        1
PREPACK PRICE        $ 3.05
RETURN COUNT         0
RETURN PRICE         $ 0.00
NO SALE OPEN COUNT   0

PAY SUMMARY
CASH      26      $ 1242.70
PIN/CHIP  2       $ 12.50
CHECK     2       $ 82.00
CREDIT CARD 5     $ 84.40
CREDIT NOTE 2    $ 61.00
COUPON    3       $ 17.00
BONUS POINT 0    $ 0.00
CREDIT SALES 3   $ 60.00
CHANGE    17     $ 287.46

TAX SUMMARY
1:10.00%,Internal      $ 67.39
2:10.00%,External     $ 242.00
3: 8.00%,Internal      $ 190.95
4: 0.00%                $ 0.00
5: 0.00%                $ 0.00
6: 0.00%                $ 0.00
7: 0.00%                $ 0.00
8: 0.00%                $ 0.00
9: 0.00%                $ 0.00
=====
    
```

► Sample(Label) - Scale Report

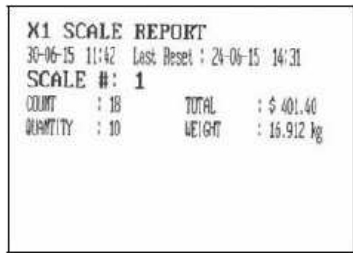

2.15.5 X1/X2 PLU Report (Menu code 1612/1632)

(MENU → 6. Report → 1. X1 Report /3. X2 Report → 2. PLU Report)

Press "2" key on X1/X2 Report menu screen.
Enter PLU range to check.

EX) dept 1, PLU 1 ~ 10

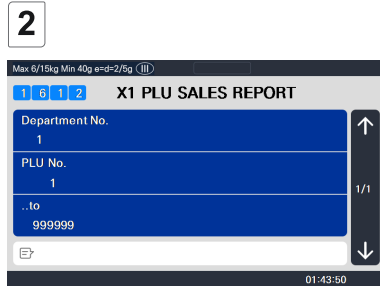

Enter PLU range to check.

EX) dept 1, PLU 1 ~ 10

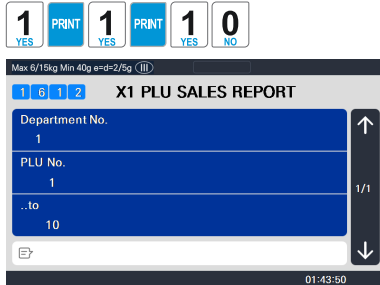

PLU sales report is shown on the display by pressing "PRINT" key.

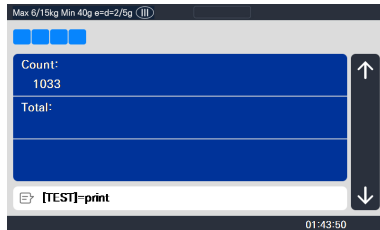

To print report, press "TEST" key.

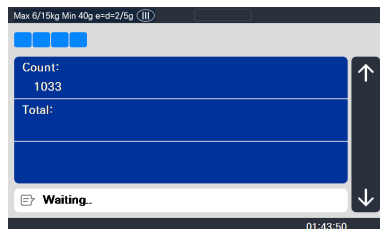

* If you print report in label mode, rewind motor does not operated so you remove label and then press the PEED key.

To exit this menu, press the "ESC" key.

Note: PLU with no sales is not printed.

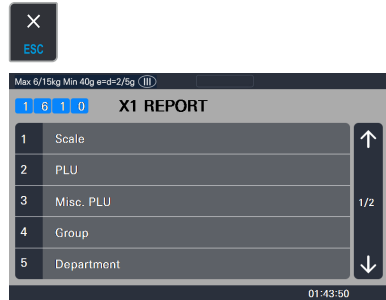

► Sample(Ticket) - PLU Report

```

XI SCALE REPORT
AUG-23-04(MON) 09:46:36 AM
Last Reset
AUG-16-04(MON) 03:33:14 PM
Start No:00000, End No:99999
=====
DEPT #01 Default
-----
PLU #00001 APPLE
TRANSACTION COUNT      84
WEIGHT                 74.828 kg
QUANTITY                0
PRICE                  $ 681.79
TAX PRICE               $ 67.39
PLU #00002 BANANA
TRANSACTION COUNT      96
WEIGHT                 0.000 kg
QUANTITY               98
PRICE                  $ 1994.00
TAX PRICE               $ 196.00
PLU #00003 ORANGE
TRANSACTION COUNT      61
WEIGHT                 0.000 kg
QUANTITY               62
PRICE                  $ 1994.00
TAX PRICE               $ 196.00
...
=====
    
```

► Sample(Label) - PLU Report

```

X1 PLU REPORT
30-06-15 13:27 Last Reset : 24-06-15 14:31
PLU #: 1 ~ 50
COUNT : 18      TOTAL : $ 401.40
QUANTITY : 10    WEIGHT : 16.912 kg
    
```

2.15.6 X1/X2 Miscellaneous PLU Report (Menu code 1613/1633)

(MENU → 6. Report → 1. X1 Report /3. Report → 3. MISC. PLU)

Press "3" key on X1/X2 Report menu screen.



Enter the number to check.

0 : Miscellaneous by-Weight

1 : Miscellaneous by-count

2 : Miscellaneous by-pcs

Ex) Misc. by-weight, Misc. by-count, Misc. by-pcs

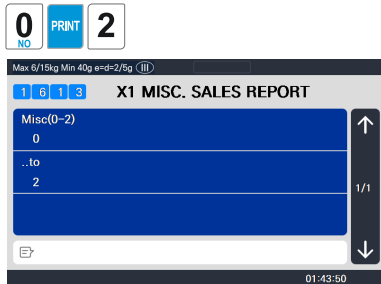

Sales report is shown on the display by pressing "PRINT" key.

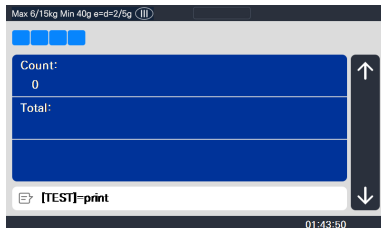

To print report, press "TEST" key.

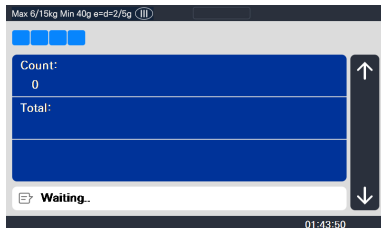

* If you print report in label mode, rewind motor does not operated so you remove label and then press the FEED key.

To exit this menu, press the "ESC" key.

Note: Misc. PLU with no sales is not printed.

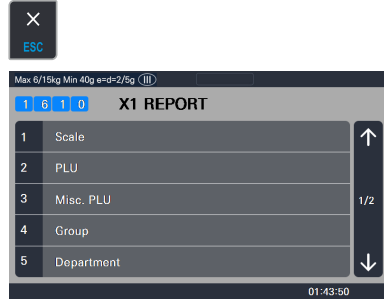

► Sample(Ticket) - Miscellaneous Report

```

XI SCALE REPORT
AUG-23-04(MON) 09:46:36 AM
Last Reset
AUG-16-04(MON) 03:33:14 PM
Start No:0, End No:2
=====
PLU # Misc By Weight
TRANSACTION COUNT      84
WEIGHT                 74,828 kg
QUANTITY                0
PRICE                  $ 681,79
TAX PRICE              $ 67,39
PLU # Misc by Count
TRANSACTION COUNT      96
WEIGHT                 0,000 kg
QUANTITY               98
PRICE                  $ 1994,00
TAX PRICE              $ 196,00
PLU # Misc By PCS
TRANSACTION COUNT      61
WEIGHT                 0,000 kg
QUANTITY               98
PRICE                  $ 1994,00
TAX PRICE              $ 196,00
=====
    
```

► Sample(Label) - Miscellaneous Report

```

30-06-15 13:27 Last Resel : 24-06-15 14:31
Misc By Weight, Misc By
COUNT : 3          TOTAL : $ 80,79
QUANTITY : 1       WEIGHT : 4,306 kg
    
```

2.15.7 X1/X2 Group Report (Menu code 1614/1644)

(MENU → 6. Report → 1. X1 Report /X2. Report → 4. Group)

Press "4" key on X1/X2 Report menu screen.



Enter group range to check
If you do not set group in PLU setting, it is
1 : Miscellaneous by-count

Ex) Group 0 ~ Group 23

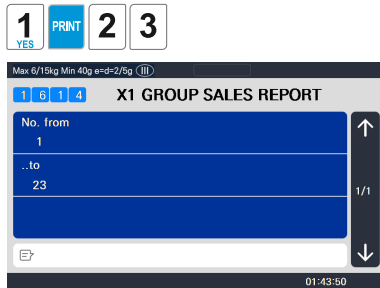

You can see group sales data by pressing
"PRINT" key.

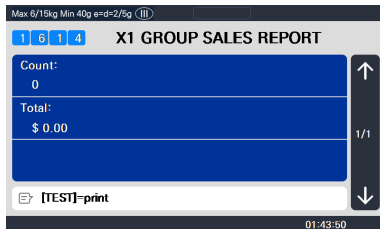

To print report, press the "TEST" key.

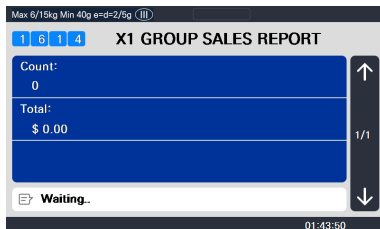

Note: Because of auto gap sensor printer will not print on where the gap is??

To exit this menu, press "ESC" key.

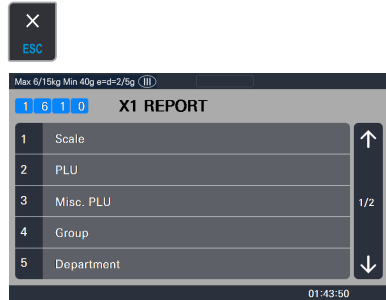

Note: Misc. If the setting of MENU 1872, "Print All Report within Range" is "No", the group with no sales is not printed. But if "Yes", all group sales data within the range is printed.

► Sample(Ticket) - Group Report

```

X1 SCALE REPORT
AUG-23-04(MON) 09:46:36 AM
Last Reset
AUG-16-04(MON) 03:33:14 PM
Start No:00, End No:99
=====
GROUP #00 NO Assigned PLU Group
-----
TOTAL COUNT          276
TOTAL PRICE          $5993,70
PREPACK COUNT        1
PREPACK PRICE        $ 3,05
-----
GROUP #01 Vegetable
-----
TOTAL COUNT          276
TOTAL PRICE          $5993,70
PREPACK COUNT        1
PREPACK PRICE        $ 3,05
-----
GROUP #02 Fruit
-----
TOTAL COUNT          276
TOTAL PRICE          $5993,70
PREPACK COUNT        1
PREPACK PRICE        $ 3,05
-----
...
=====
    
```

► Sample(Label) - Group Report

```

X1 GROUP REPORT
30-06-15 13:28 Last Reset : 24-06-15 14:31
GROUP #: 0
COUNT : 21      TOTAL : $ 482,19
QUANTITY : 11    WEIGHT : 21,218 kg
    
```

2.15.8 X1/X2 Department Sales Report (Menu code 1615/1635)

(MENU → 6. Report → 1. X1 Report /3.X2 Report → 5. Department)

Press "5" key on X1/X2 Report menu screen.



Enter department range to check.

EX) dept 1 ~ dept 10

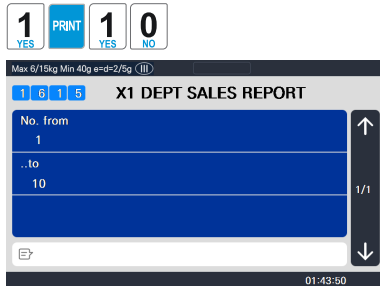

You can see department sales data by pressing "PRINT" key.



To print report, press the "TEST" key.

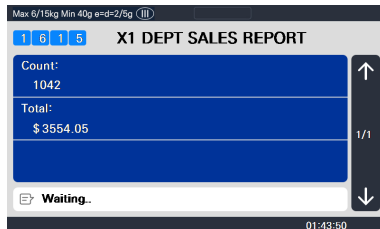

* To exit this menu, press "ESC" key.

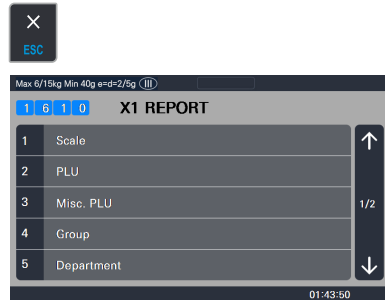

Note: If the setting of MENU 1872, "Print All Report within Range" is "No", the department with no sales is not printed. But if "Yes", all department sales data within the range is printed.

► Sample(Ticket) - Department Report

```

X1 SCALE REPORT
AUG-23-04(MON) 09:46:36 AM
Last Reset
AUG-16-04(MON) 03:33:14 PM
Start No:01, End No:99
=====
DEPT #01 Default
-----
TOTAL COUNT          274
TOTAL PRICE          $5993,70
PREPACK COUNT         1
PREPACK PRICE        $ 3,05
RETURN COUNT          0
RETURN PRICE         $ 0,00
-----
DEPT #02 MEET
-----
TOTAL COUNT          274
TOTAL PRICE          $5993,70
PREPACK COUNT         1
PREPACK PRICE        $ 3,05
RETURN COUNT          0
RETURN PRICE         $ 0,00
-----
DEPT #03 FISH
-----
TOTAL COUNT          274
TOTAL PRICE          $5993,70
PREPACK COUNT         1
PREPACK PRICE        $ 3,05
RETURN COUNT          0
RETURN PRICE         $ 0,00
-----
...
=====
    
```

► Sample(Label) - Department Report

```

X1 DEPARTMENT REPORT
30-06-15 13:28 Last Reset : 24-06-15 14:31
DEPT #: 1
COUNT : 21      TOTAL : $ 482,19
QUANTITY : 11    WEIGHT : 21,218 kg
    
```

2.15.9 X1/X2 Hourly Sales Report (Menu code 1616/1636)

(MENU → 6. Report → 1. X1 Report /3.X2 Report → 6. Hourly)

Press "6" key on X1/X2 Report menu screen.

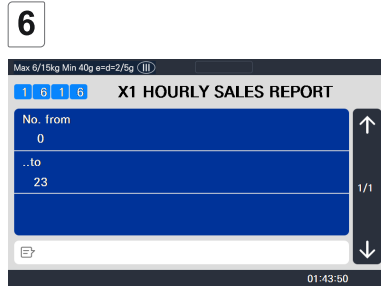

Enter time to check.

EX) AM 9 hour ~ PM 2 hour

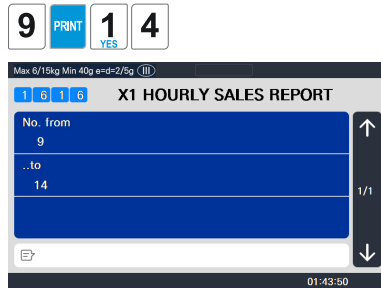

You can see hourly sales data by pressing "PRINT" key.



To print report, press "TEST" key.

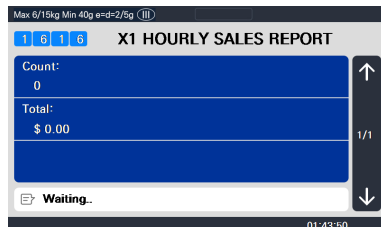

* To exit this menu, press "ESC" key

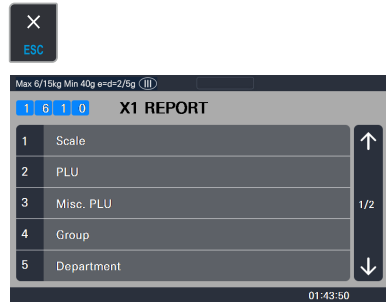

Note: If the setting of MENU 1872, "Print All Report within Range" is No, the hour with no sales is not printed. But if "Yes", all hour sales data within the range is printed.

► Sample(Ticket) - hourly Report

```

X1 SCALE REPORT
AUG-23-04(MON) 09:46:36 AM
Last Reset
AUG-16-04(MON) 03:33:14 PM
Start No:00, End No:23
=====
HOUR #10
-----
TOTAL COUNT          274
TOTAL PRICE          $5993,70
PREPACK COUNT        1
PREPACK PRICE        $ 3,05
-----
HOUR #11
-----
TOTAL COUNT          274
TOTAL PRICE          $5993,70
PREPACK COUNT        1
PREPACK PRICE        $ 3,05
-----
HOUR #13
-----
TOTAL COUNT          274
TOTAL PRICE          $5993,70
PREPACK COUNT        1
PREPACK PRICE        $ 3,05
=====
    
```

► Sample(Label) - hourly Report

```

X1 HOURLY REPORT
30-06-15 13:10 Last Reset : 24-06-15 14:31
HOUR # : 10 ~ 23
COUNT : 21 TOTAL : $ 482,19
QUANTITY : 11 WEIGHT : 21,218 kg
    
```

2.15.10 X1/X2 Clerk Sales Report (Menu code 1617/1637)

(MENU → 6. Report → 1. X1 Report /3.X2 Report → 7. Clerk)

Press "7" key on X1/X2 Report menu screen.



Enter clerk range to check.

EX) clerk 0 ~ clerk 95

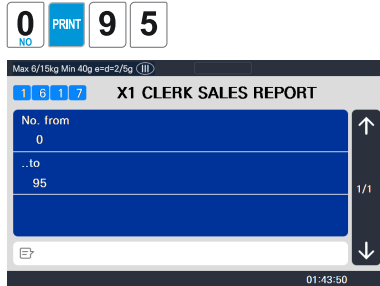

You can see hourly sales data by pressing "PRINT" key.



To print report, press "TEST" key.

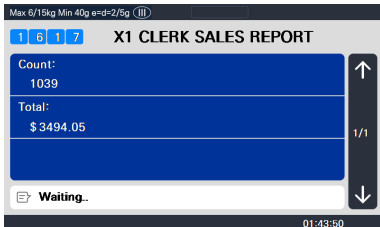

* To exit this menu, press "ESC" key

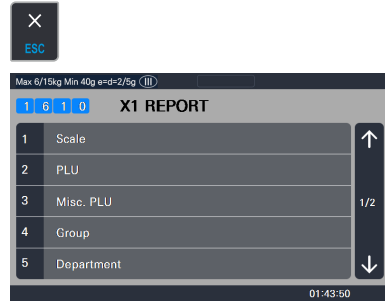

Note: If the setting of MENU 1872, "Print All Report within Range" is No, the hour with no sales is not printed. But if "Yes", all hour sales data within the range is printed.

► Sample(Ticket) - Clerk Report

```

X1 SCALE REPORT
X1 CLERK REPORT
AUG-23-04(MON) 09:46:36 AM
Last Reset
AUG-16-04(MON) 03:33:14 PM
Start No:00, End No:99
=====
CLERK #00 MANAGER
-----
TOTAL COUNT                267
TOTAL PRICE                 $ 5693,70
VOID COUNT                  3
VOID PRICE                  $ 27,30
REPACK COUNT                0
REPACK PRICE                $ 0,00
OVERRIDE COUNT             0
OVERRIDE PRICE              $ 0,00
DISCOUNT COUNT            0
DISCOUNT PRICE            $ 0,00
PREPACK COUNT               1
PREPACK PRICE               $ 3,05
RETURN COUNT                0
RETURN PRICE                $ 0,00
NEGATIVE COUNT              0
NEGATIVE PRICE              $ 0,00
NO SALE OPEN COUNT         0
PAY SUMMARY
CASH                26      $ 1242,70
PIN/CHIP             2      $ 12,50
CHECK                 2      $ 82,00
CREDIT CARD           5      $ 84,40
CREDIT NOTE           2      $ 61,00
COUPON                 3      $ 17,00
BONUS POINT           0      $ 0,00
CREDIT SALES          3      $ 60,00
CHANGE                17     $ 287,46
-----
CLERK #01 CLERK
-----
TOTAL COUNT                267
TOTAL PRICE                 $ 5693,70
. . .
-----
CLERK #02 AHN
-----
TOTAL COUNT                267
TOTAL PRICE                 $ 5693,70
. . .
=====
    
```

► Sample(Label) - Clerk Report

```

X1 CLERK REPORT
30-06-15 13:11 Last Reset : 24-06-15 14:31
CLERK #: 0
COUNT : 11      TOTAL : $ 282,19
QUANTITY : 1     WEIGHT : 21,218 kg
    
```

2.15.11 Z1/Z2 Report (Menu code 1620/1640)

(MENU → 6. Report → 2. Z1 Report / 4. Z2 Report)

If you select menu code 1620, you will see following screen.



If you want to print and clear the data, press TEST key. The scale shows following screen.

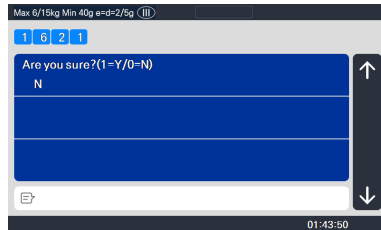

To print and clear, press "1" key. The scale shows following screen.

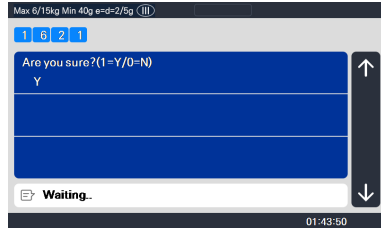

When printing is done, Z1 data is cleared and exit this menu.

Sales data is same with X1 report

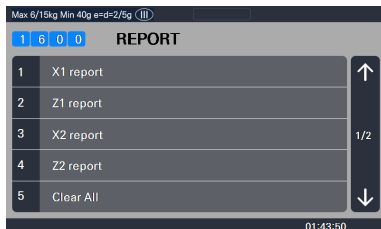

Note1: If the setting of Parameter 598, "Print when Z Report clear" is "No", you cannot print Z Report.

Note2: If the setting of Parameter 595 "Individual clear(Z report)" is "Yes", you can clear Scale, PLU, Misc. PLU, Group, Department, Hourly, Clerk data is cleared separately.

But if you use this function, each report is not same with scale report.

2.15.12 Clear All Report (Menu code 1650)

(MENU → 6. Report → 5. Clear All)

If you select menu code 1650, you will see following screen.



To clear all report, press 1 key. If you do not want to clear, press 0 or ESC key.

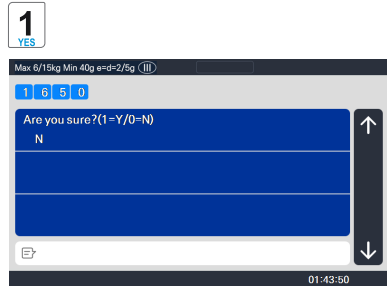

3. SALES OPERATION

3.1 Basic Operation

This chapter explains basic operation of scale, such as how to set zero, tare, call up a PLU and override unit price in CN1 series.

- Turn ON the scale. The first screen will be seen as below for CN1.

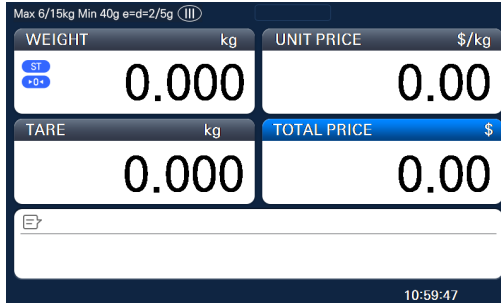

3.2 Zero (▶ 0 ◀)

You can use the ZERO key to correct for a deviation from zero as long as there are no PLUs or MISC PLUs called-up. The weight can sometimes drift from zero due to debris on the platter, leaving objects on the platter for excessive periods of time, or other environmental factors.

To correct this, remove everything from the platter and press the ZERO key when the stable indicator “▼” is on. Below is a possible zero drifted state that should be corrected by simply pressing the ZERO key.

① EX) Initial weight displayed → 0.002.



② Press “ZERO” key to set initial zero.



3.3 Tare (▶T◀)

You can enter tare weights as long as there are no PLUs or MISC PLUs called-up.

If you need to temporarily override a PLU's tare weight, you must enter the tare weight first and then call-up that PLU. There are two ways to enter a tare weight and both ways will only work if there is no PLU or MISC PLU called-up.

3.3.1 Manual Tare Entry 1

- Enter a tare weight manually by pressing the numeric keys EX) 150 g



- Press "TARE" key.

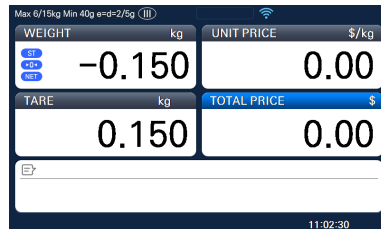

3.3.2 Weighed Tare Entry

- Place the empty container on the platter making sure that the weight is stable EX) 0.2 kg

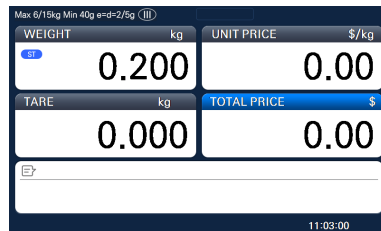

- Press "TARE" key.

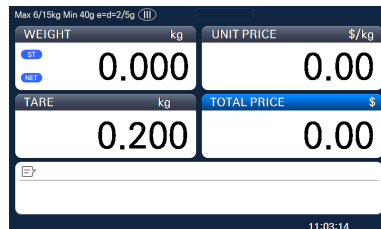

3.3.3 How to Clear Tare

- ① Remove the item from the platter



- ② Press "TARE" key again.



3.3.4 Preset Tare

- ① Call up a PLU including tare(weight of container).
EX) PLU #3 s tare =150 g



- ② Clear PLU#3, then tare is also automatically cleared.

3.4 Calling Up a PLU

There are two ways to call up a PLU by using numeric key and preset key (speed key).

3.4.1 Using Numeric Key

- ① Enter PLU number by using numeric keys and press "PLU" key.
EX) PLU No. 15



Note: Even though you do not press PLU key after entering a PLU number, PLU will be displayed depending on the setting time. It takes time to call up a PLU depending on the setting of parameter, 586 "Indirect PLU Call Time".

3.4.2 Using Speed Key

To call-up PLU number 79, and you programmed Speed key #5 to be PLU number 79, then you need to press the following key: Speed key #5.

Note: You have to set Speed key in program mode (Menu 1160 on chapter 2.6)

- ① Press a speed key (which is save as a PLU).
EX) PLU #79=Apple, Speed key #5

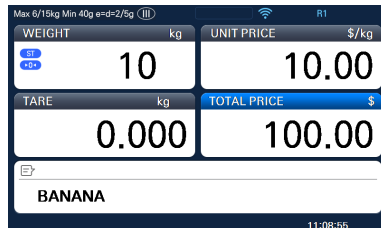

3.5 Override (FOR key)

The OVERRIDE key is used to temporarily change the pricing of priced PLUs.

- ➔ If you set program menu 1873(Save unit price change), changed priced is saved after printing a label.

3.5.1 By-Weight PLU

- PLU# 1.MEAT (PLU Type : By weight, Unit Price : 1.99\$).

- ① Press OVERRIDE key.

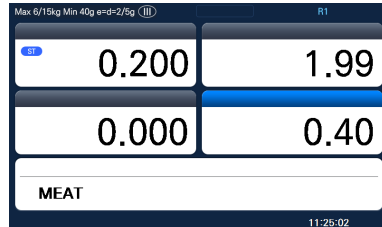

- ② Enter new unit price.

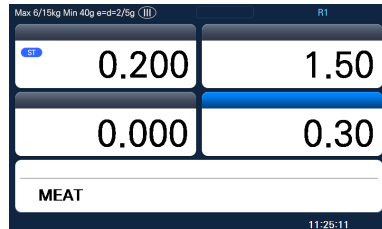

- ③ Press PRINT key to print label.

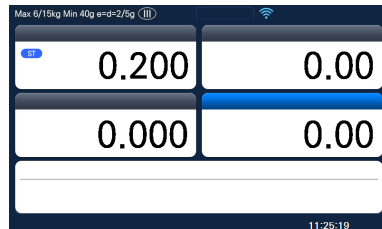

3.5.2 By-Count PLU

- PLU# 2.APPLE (PLU Type : By count, Unit Price : 1.00\$).

① Press OVERRIDE key.



② Enter QUANTITY and press FOR key.

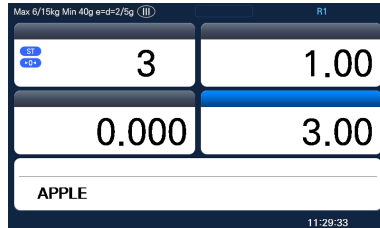

③ Enter new unit price.



④ Enter QUANTITY and press FOR key.

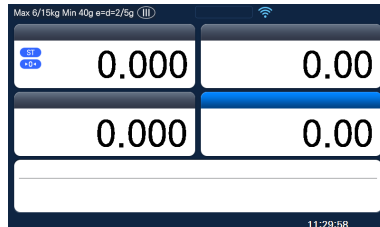

3.5.3 By-PCS PLU

- PLU# 3.Eggs (PLU Type : By PCS, Pieces : 3, Unit Price : 30.00\$).

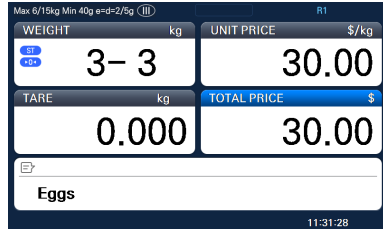

① Press OVERRIDE key and enter new unit price.

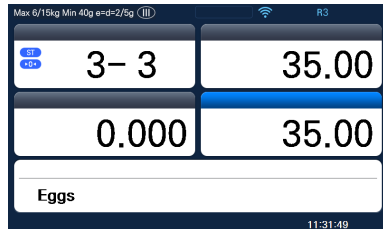

② Press FOR key and enter QUANTITY

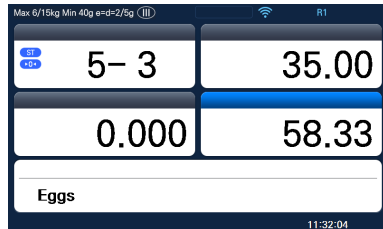

③ Press FOR key and enter PIECES

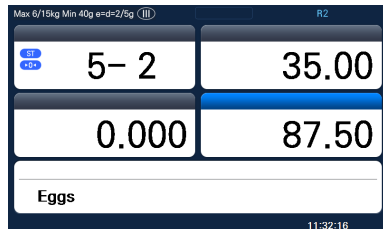

④ Press PRINT key to print label.



Note: - If you set program menu 1873(Save unit price change), changed priced is saved after printing a label.

- If you set parameter 501(Ride Second Position), you can change unit price of by-count PLU and pcs of by-pcs PLU directly.
- Discount function is not available when you use OVERRIDE key.

3.6 Sales Operation

3.6.1 Weighed Item Operation

EXAMPLE:

- PLU No : 29, PLU Name: ONION, PLU type : by weight, Unit Price : 1.50\$,
- Sales Weight =1.0kg

① Press Speed key to call up a PLU.



Max 6/15kg Min 40g e=d=2/5g (III)	
WEIGHT	UNIT PRICE
kg 0.000	\$/kg 1.50
TARE	TOTAL PRICE
kg 0.000	\$ 0.00
ONION	
11:35:55	

User may call up a PLU by pressing speed key or numeric key. Please refer to chapter 3.4 for details.

② Place the item(s) on the platter.



Max 6/15kg Min 40g e=d=2/5g (III)	
WEIGHT	UNIT PRICE
kg 1.000	\$/kg 1.50
TARE	TOTAL PRICE
kg 0.000	\$ 1.50
ONION	
03:11:00	

③ Press "PRINT" key to print a label and complete current transaction.
This transaction(s) is saved in the sales record.



Max 6/15kg Min 40g e=d=2/5g (III)	
WEIGHT	UNIT PRICE
kg 1.000	\$/kg 0.00
TARE	TOTAL PRICE
kg 0.000	\$ 0.00
ONION	
03:11:18	

④ Remove the item(s) from the platter.



Max 6/15kg Min 40g e=d=2/5g (III)	
WEIGHT	UNIT PRICE
kg 0.000	\$/kg 0.00
TARE	TOTAL PRICE
kg 0.000	\$ 0.00
ONION	
03:12:01	

* Total Price= Sales weight X Unit price

Note: - In "SAVE" & "Prepack" mode the PLU is not automatically cleared when you remove the item from the platter.
 - If you set "PLU clr Aft sale(WT.OnTray)" to "Y" in Menu 1873, PLU is cleared even though you do not remove the item from the platter. (See chapter 2.14.7.3 for menu 1873)

3.6.2 By Count Item

EXAMPLE:

- PLU No : 31, PLU Name: MANGO, PLU type = By-Count, Unit Price: 1.99\$,
- Sales 20 pieces.

① Press numeric key(s) to call up a PLU.

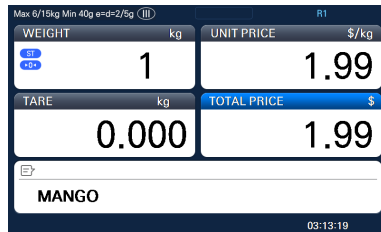

User may call up a PLU by pressing speed key or numeric key. Please refer to chapter 3.4 for details.

② Enter the number of pieces.
 EX) 20 pieces.



③ Press "PRINT" key to print a label and complete current transaction.
 This transaction(s) is saved in the sales record.



* Total Price= Piece(s) X Unit price

Note: - In "SAVE" & "Prepack" mode, the PLU called up is not automatically cleared when you remove the item from the platter.

3.6.3 By PCS Item

EXAMPLE:

- PLU No : 30, PLU Name: ORANGE, PLU type = By PCS, PIECES: 5,
Unit Price : 1.99\$
- Sales = 20 pieces. [QUANTITY item]

① Press numeric key(s) to call up a PLU.

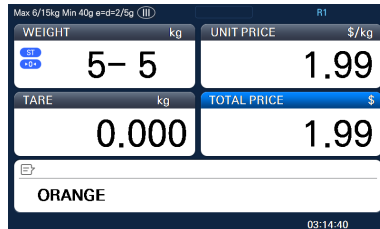

User may call up a PLU by pressing speed key or numeric key. Please refer to page 143 for details.

② Enter QUANTITY [the number of Pieces].
EX) 20 pieces.

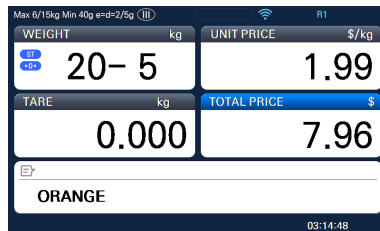

③ Press “PRINT” key to print a label and complete current transaction.
This transaction(s) is saved in the sales record.



* Total Price= QUANTITY X [Unit price / PIECES]

Note: - In “SAVE” & “Prepack” mode the PLU is not automatically cleared when you remove the item from the platter.

3.7 Discount

Before using discount function, you have to set discount data in menu 1130 of program mode. Discount is different depending on PLU type. (For details, see chapter 2.4.1)

3.7.1 Unit Price Discount - By Weight PLU

EXAMPLE:

- PLU# 29=Water Melon (By-Weight PLU), Unit price=20.00

- 1st Target of Discount: "Discount amount from unit price"=0.50 for weight 0.500.
- 2nd Target of Discount: "Discount amount from unit price"=1.00 for weight 1.000.

① Call up a PLU.

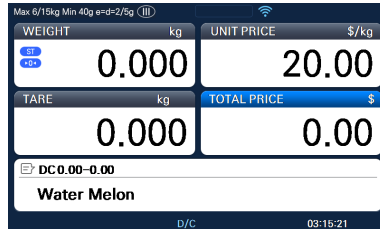

② Place an item on the platter. In this case, discount is not available because the weight of this item (0.460 kg) is lower than 1st target(0.500 kg).

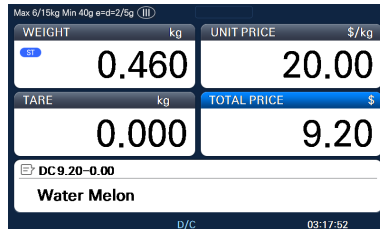

③ Place an item on the platter. In this case, discount is possible because the weight of item(0.534 kg) is greater than 1st target (0.500kg) therefore the total price is 10.41.

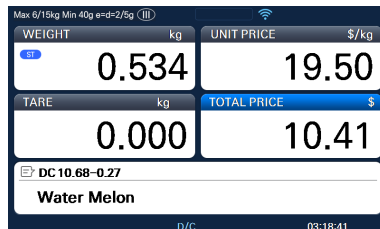

- ④ Place items on the platter. In this case, discount is possible because the weight of item(1.014 kg) is greater than 1st target(0.500kg) therefore the total price is 19.27\$.



Max 6/15kg Min 40g e=d=2/5g (III)		UNIT PRICE \$/kg	
WEIGHT kg	1.014	UNIT PRICE \$/kg	19.00
TARE kg	0.000	TOTAL PRICE \$	19.27
DC 20.28-1.01			
Water Melon			
D/C		03:21:50	

- ⑤ Press the PRINT key. Markdown(STRIKE THROUGH) is printed on label as figure.

Note: - You can set four markdown information in menu 1720 of program mode.(See chapter 2.13.3)
 - If you set "display discount info." to "Y" in menu 1871 of program mode, you can see total price and discount information on the display. (See chapter 2.14.21)

3.7.2 % Unit Price Discount - By Weight PLU

EXAMPLE:

- PLU# 29=ORANGE (By-Weight PLU), Unit price=20.00

- 1st Target of Discount: "10 % off from unit price" for sales weight 0.500 kg.
- 2nd Target of Discount: "20 % off from unit price" for sales weight 1.000 kg.

- ① Call up a PLU.



Max 6/15kg Min 40g e=d=2/5g (III)		UNIT PRICE \$/kg	
WEIGHT kg	0.000	UNIT PRICE \$/kg	20.00
TARE kg	0.000	TOTAL PRICE \$	0.00
DC 0.00-0.00			
ORANGE			
D/C		03:24:37	

* User may call up a PLU by pressing speed key or numeric key. Please refer to chapter 3.4 for details.

- ② Place an item on the platter. In this case, discount is not available because the weight of this item (0.460 kg) is lower than 1st target(0.500 kg).



Max 6/15kg Min 40g e=d=2/5g (III)		UNIT PRICE \$/kg	
WEIGHT kg	0.460	UNIT PRICE \$/kg	20.00
TARE kg	0.000	TOTAL PRICE \$	9.20
DC 9.20-0.00			
ORANGE			
D/C		03:26:18	

- ③ Place items on the platter. In this case, the weight of items(0.516 kg) is greater than 1st target(0.500 kg) therefore you can have 10% discount. (Total price is 9.29)



Max 6/15kg Min 40g e=d=2/5g (III)			
WEIGHT	kg	UNIT PRICE	\$/kg
0.516		0.00	
TARE	kg	TOTAL PRICE	\$
0.000		0.00	
DC 21.52-4.30			
ORANGE			
		03:29:03	

- ④ Place items on the platter. In this case, the weight of items(1.076kg) is greater than 2nd target(1.000kg) therefore you can have 20% discount. (Total price is 16.22)



Max 6/15kg Min 40g e=d=2/5g (III)			
WEIGHT	kg	UNIT PRICE	\$/kg
1.076		16.00	
TARE	kg	TOTAL PRICE	\$
0.000		17.22	
DC 21.52-4.30			
ORANGE			
		03:39:00	

- ⑤ Press the PRINT key. Markdown(STRIKE THROUGH) is printed on label as figure.



3.7.3 Unit Price Discount - By PCS PLU

EXAMPLE 2:

- PLU# 30=PREMIUM MANGO, 3 pieces FOR 6.00

- 1st Target of Discount: "Discount amount from unit price"=0.20 for sales 5 pieces.
- 2nd Target of Discount: "Discount amount from unit price"=0.50 for sales 10 pieces.

① Call up a PLU.



Max 6/15kg Min 40g e=d=2/5g (III)		R1	
WEIGHT	kg	UNIT PRICE	\$/kg
5- 5		1.99	
TARE	kg	TOTAL PRICE	\$
0.000		1.99	
ORANGE			

② Enter quantity. In this case, 5 is greater than 1st Target (5), unit price(0.20\$) is discounted.



Max 6/15kg Min 40g e=d=2/5g (III)		R1	
WEIGHT	kg	UNIT PRICE	\$/kg
5- 5		1.99	
TARE	kg	TOTAL PRICE	\$
0.000		1.99	
ORANGE			

③ Enter quantity. In this case, 11 is greater than 2nd Target (10), unit price(0.50\$) is discounted.



Max 6/15kg Min 40g e=d=2/5g (III)		R1	
WEIGHT	kg	UNIT PRICE	\$/kg
5- 5		1.99	
TARE	kg	TOTAL PRICE	\$
0.000		1.99	
ORANGE			

⑤ Press the PRINT key. Markdown(STRIKE THROUGH) is printed on label as figure.



Note: - You can set four markdown information in menu 1720 of program mode.(See chapter 2.13.3)

3.8 Add-Up Transaction

If you press the ADD key instead of the PRINT key, you will initiate the ADD-UP process. You can ADD-UP 399 items maximum.

EXAMPLE 2:

- PLU# 32=SIRLOIN, PLU Type = By-Weight, Unit Price=15.00,
- PLU# 35=T-bone Steak, PLU Type = By-PCS, Pieces=3, Unit Price=6.00

① Call up a PLU and place item on the platter.



Max 6/15kg Min 40g e=d=2/5g (III)	
WEIGHT	UNIT PRICE
0.652 kg	15.00 \$/kg
TARE	TOTAL PRICE
0.000 kg	9.78 \$
SIRLOIN	
03:43:58	

② Press ADD key. PLU is cleared automatically. You will see the display as below. Remove item from the platter.



Max 6/15kg Min 40g e=d=2/5g (III)	
WEIGHT	UNIT PRICE
0.650 kg	0.00 \$/kg
TARE	TOTAL PRICE
0.000 kg	0.00 \$
ADD 1 \$ 9.78	
03:44:21	

③ Call up a PLU. and place item on the platter



Max 6/15kg Min 40g e=d=2/5g (III)		R1
WEIGHT	UNIT PRICE	
2-3 kg	6.00 \$/kg	
TARE	TOTAL PRICE	
0.000 kg	4.00 \$	
ADD 1 \$ 9.78		
STEAK		
03:45:12		

④ Press ADD key. PLU is cleared automatically. You will see the display as below.



Max 6/15kg Min 40g e=d=2/5g (III)	
WEIGHT	UNIT PRICE
0.000 kg	0.00 \$/kg
TARE	TOTAL PRICE
0.000 kg	0.00 \$
ADD 2 \$ 13.78	
03:46:06	

- ⑤ You can repeat the ADD-UP process up to 100 times or you can press the ST/TTL key at anytime to see the grand-total.

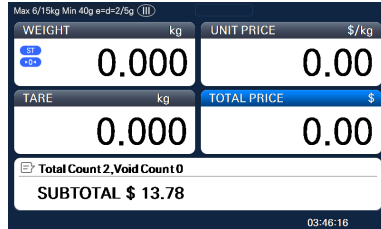

- ⑥ To complete the sale, press the PRINT key.
(To repeat the ADD-UP process, press the ESC key.)



Note: - You can press the VOID key to undo the transaction. (See chapter 3.10).

- If you set "Print Item Label" to "Y" in menu 1750 of program mode, label will be printed whenever you press the ADD key. (See chapter 2.13.3)
- Even though you turn off the scale before printing a grand total label, add-up data is not cleared.

3.9 Clerk Operation

There are three clerk modes as below.

► Clerk Modes

No	Clerk Modes	Description
1	No Clerk	Sales clerk does not log in and makes sales using “PRINT” key.
2	Standard Clerk	Generating a standard clerk transaction is the same as any sales mode transaction except that you do NOT press the PRINT key; instead you must press one of the V(Clerk-Speed) keys (1 through 4) You can print total price label depending on the setting.
3	Floating Clerk	Generating a standard clerk transaction is the same as any sales mode transaction except that you do NOT press the PRINT key; instead you must press one of the V(Clerk-Speed) keys (1 through 4) You can print total price label depending on the setting. Sales data is added automatically.

☞ To register clerk, refer to menu code 1850 of program mode. (See chapter 2.14.5)

Assumption

- Clerk should be registered on menu 1850. (See chapter 2.14.5)
- Clerk number should be set on menu 1856 to use “V1~V64” keys (See chapter 2.14.5.6) If the clerk is not assigned to V1~V64, this clerk has to enter password after pressing V key.
- All clerks can use “V” key.
- * Up to 100 transactions are available in Clerk mode
- * Sales data is saved in memory.
- * If you press PRINT key to complete transaction, grand total price is printed and sales data is cleared from memory.
- * If you want to see total price before completing transaction, press the ST/TTL key. To print, press the PRINT key.
- * Even though you turn off the scale before printing, sales data is not cleared.
- If you want to print ticket when you log out, press V1~V64 to log on and press the PRINT key. You can also check total price by pressing ST/TTL key after log on.

Note: - You have to set Clerk log out time in menu 1874 of program mode.
 (See chapter 2.14.7) If you do not call a PLU and do not operate the scale, time is computed.
 To set 30 seconds for logout time, enter 300. If you do not want to log out, enter 0.

- When there is no PLU, you can print ticket again by pressing X key
 (It depends on the setting of parameter 599, Print last ticket)

3.9.1 Standard Clerk Operation

Assumption

- You have to set "Select Clerk Sale mode" to "2" (Standard Clerk) in menu 1820 of program mode. (See chapter 2.14.3)

EXAMPLE 2:

Clerk No: 2, Clerk Name: Christine, Clerk Key: V1
 PLU#1=Apple, Unit Price 10.00, Weight, 1.2 kg
 PLU#2=Orange, Unit Price 20.00, Weight, 1.2 kg

① Call up a PLU.



② Place an item and press V1 key. You will get a label automatically.



③ Call up a PLU.

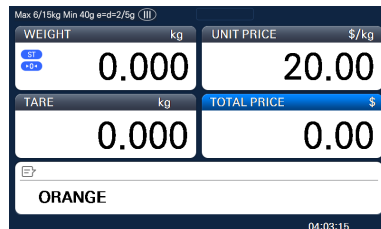

- ④ Place an item and press V1 key. You will get a label automatically.



V1

Max 6/15kg Min 40g e=d=2/5g (III)		UNIT PRICE \$/kg	
WEIGHT kg	1.200	UNIT PRICE \$/kg	20.00
TARE kg	0.000	TOTAL PRICE \$	24.00
ORANGE			
04:03:34			

- ⑤ Press the PRINT key to complete transaction. If you are in ADD-UP mode, you can have label for grand total price.



Max 6/15kg Min 40g e=d=2/5g (III)		UNIT PRICE \$/kg	
WEIGHT kg	1.200	UNIT PRICE \$/kg	0.00
TARE kg	0.000	TOTAL PRICE \$	0.00
04:06:53			

Note: - If you are in ADD-UP mode, you can have label for grand total price by pressing PRINT key. When you turn on the scale, this function is not active so you have to press ADD key.

3.9.2 Floating Clerk Operations

Assumption

- You have to set Select Clerk Sale mode to 3 (Floating Clerk) in menu 1820 of program mode. (See chapter 2.14.3)

EXAMPLE :

Clerk No: 2, Clerk Name: Christine, Clerk Key: V1
 PLU#1=Apple, Unit Price 10.00.
 PLU#2=Orange, Unit Price 20.00 10 pieces.

- ① Call up a PLU.



Max 6/15kg Min 40g e=d=2/5g (III)		UNIT PRICE \$/kg	
WEIGHT kg	0.000	UNIT PRICE \$/kg	10.00
TARE kg	0.000	TOTAL PRICE \$	0.00
APPLE			
04:07:56			

- ② Place an item on the platter and press the V1 key.
This transaction is save to memory.



V1

Max 6/15kg Min 40g e=d=2/5g (III)	
WEIGHT kg	UNIT PRICE \$/kg
1.200	0.00
TARE kg	TOTAL PRICE \$
0.000	0.00
04:08:44	

- ③ Call up a PLU #2.



Max 6/15kg Min 40g e=d=2/5g (III)	
WEIGHT kg	UNIT PRICE \$/kg
0-10	20.00
TARE kg	TOTAL PRICE \$
0.000	0.00
ORANGE	
04:19:13	

- ④ Place an item on the platter and press the V1 key.
This transaction is saved to memory.



V1

Max 6/15kg Min 40g e=d=2/5g (III)	
WEIGHT kg	UNIT PRICE \$/kg
12-10	20.00
TARE kg	TOTAL PRICE \$
0.000	24.00
ORANGE	
04:27:07	

- ⑤ Press the PRINT key to complete transaction.
Grand total price label is printed and sales data is cleared in memory.



Max 6/15kg Min 40g e=d=2/5g (III)	
# 2 Total Count 2_Void Count 0	
Total \$ 36.00	
Chris	

Note: - Print mode of floating clerk operation is ticket type as default.

If you want to use label type, you have to change setting in menu 1731 of program mode. (See chapter 2.13.3)

- You can set ticket item in menu 1761 of program mode. (See chapter 2.13.6)

3.10 Void

You can press the VOID key to undo transaction in add-up process or floating clerk operation.

Assumption)

You sold several items

◆ If there is no PLU or price is zero.

① Press the VOID key, you will see following screen.

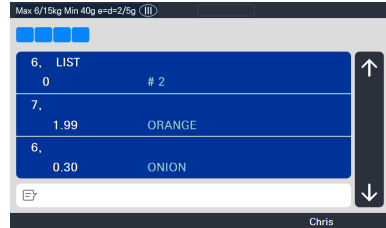

② To void ORANGE, enter 7 by pressing numeric key and press the PRINT.

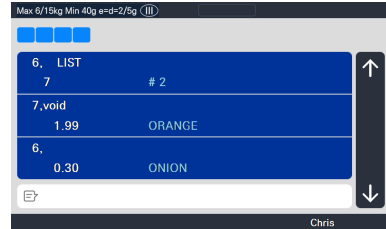

③ To void ORANGE, enter 7 by pressing

* You can use the PG UP and PG DOWN keys or the Arrow keys to navigate up and down the list.

◆ If there is same PLU and same price to void

① Place item on the platter

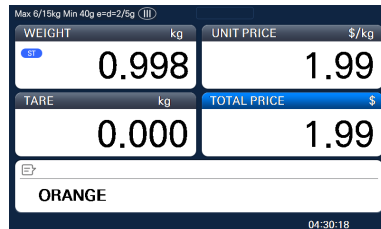

② Press VOID key then this sale is cleared.

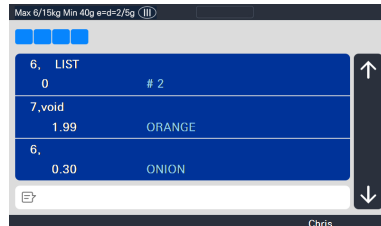

* If price is not same, void list screen is shown on the display automatically.

3.11 Payment & Change

► Payment

No	Type
0	Cash
1	Pin/chip
2	Check
3	Credit card
4	Credit note
5	Coupon
6	Bonus point
7	Credit

You can use PAY key in the add-up process or floating clerk operation.

EX) Total price : 15.00 \$

If customer give 6.00 coupon and cash 10.00 \$ to clerk

① Press PAY key when there is subtotal price

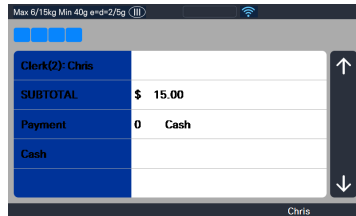

② Select payment type 5(coupon) and press PRINT key.

※ See Payment table.

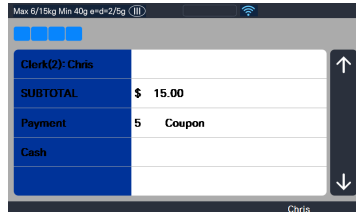

③ Enter 6.00

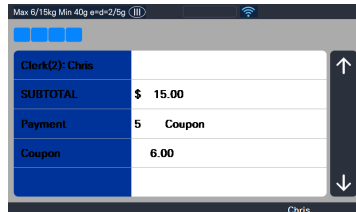

- ④ Press PRINT key then you can select payment type again.

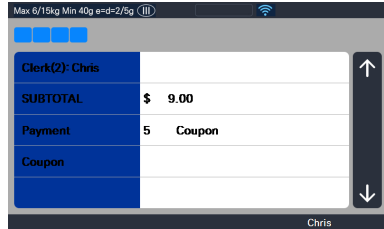

- ⑤ Select Payment type (0 cash) and press PRINT key.

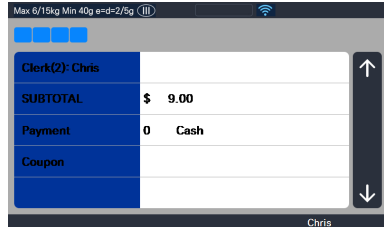

- ⑥ Enter 10.00.

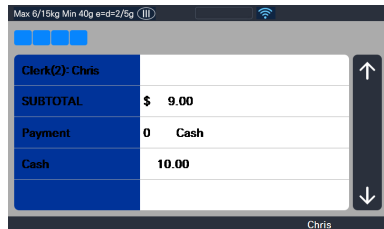

- ⑦ Press PRINT key. The label is issued.

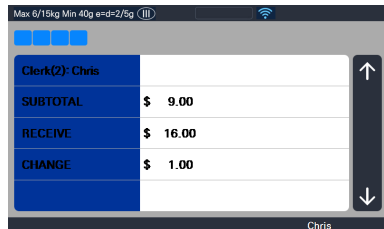

* Total price, receive and change is printed.

Note: - You can set print item in menu 1760 of program mode. (See chapter 2.13.6)
 - If there is credit sales, a receipt is printed additionally.

3.12 Return

The RETURN key is used to delete erroneous sale transactions. You can use the RETURN key to undo erroneous sales transactions like pressing the PRINT key inadvertently, selecting and printing the wrong PLU, an inadvertent Auto-Print in Pre-Pack mode, or perhaps adjusting the sales totals for a damaged or ruined package. Whatever the reason, the RETURN function will decrement returned PLU s transaction counter and sales totals by the specified amount.

You need to call-up the PLU that you wish to return by either pressing its corresponding speed key or typing its number.

◆ When the price is zero,

0) By weight PLU : You need to enter the total price and weight that was printed on the return PLU s label

1) By count PLU: You need to enter the total price and quantity that was printed on the return PLU s label

◆ When the price is higher than zero, Return function is performed by pressing RETURN key

Note: - If you set Shift key instead return key to "Y" in menu 1873 of program mode, you cannot use return function.
(See chapter 2.14.21)

- If parameter 596 X/Z Report is not set, this function will not operated.

3.13 Prepack Key

Pre-Pack mode, it prints labels automatically. When it is in MANUAL mode, you must press the PRINT key (or ADD key) to get a label. In Pre-Pack mode, you can not select AUTO mode. Pre-Pack works like AUTO and SAVE mode except that the weight does not need to return to zero for every auto-print.

Pre-pack mode is very useful in backyard applications. This mode increases productivity by not requiring the user to press the PRINT key for every package. Instead the user can concentrate on weighing, wrapping, and labeling

This function is only available for by-weight PLU.

- how to use prepack mode
 - if you use Prepack mode without total function.
- same as current operating way
 - (put the item on the platter and then print automatically)
 - when you use the total function at Prepack Mode
 - 1) when total function starts, press [ADD] key (at Prepack Mode)
 - 2) on the display, [Summation ON] will appear for about 3 seconds.
 - 3) call up PLU and then place a item.
 - 4) each label will be automatically prints and will make a total.
 - 5) repeat 3)-4).
 - 6) when you press [ST/TTL] key, the total will be displayed.
 - 7) to print the Sub Total, press [PRINT] key.
 - 8) repeat 3)-7).
 - 9) to print Grand Total Label, press [ST/TTL]. (this case at there should be no sub-total remains, then press [ST/TTL] key)
 - 10) Grand Total Label will be printed.
 - 11) after complete the total function, press [ADD] key.
 - 12) on the Display, [Summation OFF] will be appear for about 3 second.
- Printing item
 - when you make a total with other items
- Printing item : (before) Total Price, Transaction No, Void Price, Void Count, (added) Total Weight, Total Quantity etc.
- when you make a total with only one item
 - Printing item : (before) Total Price, Transaction No, Void Price, Void Count, (added) Total Weight, Total Quantity, Dept No, Dept Name
PLU Name, Item Code, PLU No, Dept No, Cook By Date
Sell By Date/Time, Packed On Date/Time, Produced Date etc

EXAMPLE:

Speed key #1= Onion Unit price=1.50, Sales Weight=1.0kg,

① Press PREPACK key and call up a PLU

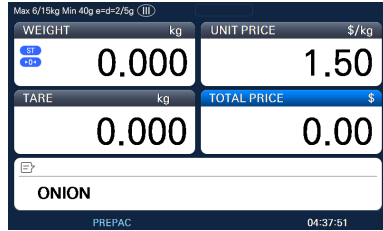

* User may call up a PLU by pressing speed key or numeric key. Please refer to Menu code 1160.

② Place the item(s) on the platter.

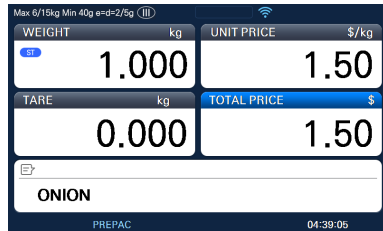

③ Label is issued automatically.



④ Remove the item(s) from the platter.

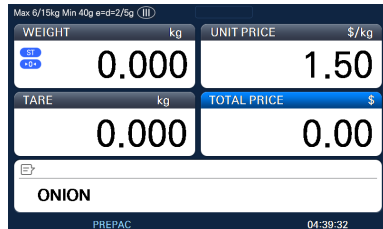

Note: - If the scale is in Prepack mode then it will always auto-print if the Total price is greater than 0.00 and:

1. The weight deviates by an amount greater than or equal to the Parameter 862 setting (Min. weight for sale) and the weight stabilizes at a weight greater than zero.
2. The weight deviates by an amount greater than or equal to the Parameter 861 setting (Auto threshold) and the weight stabilizes at a weight greater than zero.

3.14 X Key

The X key is used to print multiple transactions for the same PLU. The X key operation is called the Multi-Label function.

3.14.1 By-Weight PLU

Note: If you want to use X key for by-weight PLU, you must set Parameter 582, Use "X" key (by WT.).

EXAMPLE:

Speed key #1= "Onion" preset key, Unit price=1.50, Sales Weight=1.0kg,

- ① Call up a PLU

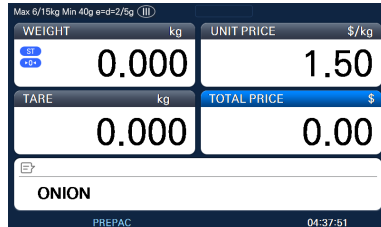

* You can call up a PLU by pressing numeric key. Please refer to chapter 3.4 for details.

- ② Place the item(s) on the platter.

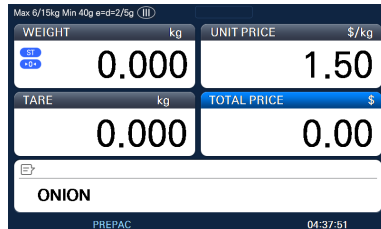

- ③ Type the number of labels you require and press the PRINT key.

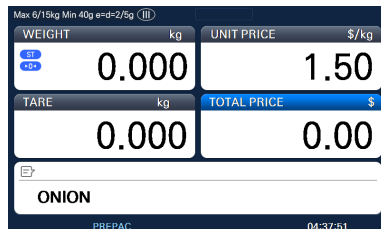

④ Remove the item(s) from the platter.



Note: - If you set "Label Prt. w.o Rewind (X Key)" to "Y" in menu 1872 of program mode, the scale does not check peel-off, so you have to press FEED key after printing is done. (See chapter 2.14.21)

- If you set "Use double print(AUTO)" to "Y" in menu 1872 of program mode, you will have two same labels in auto mode.

- If you set 2nd label in PLU programming, 2nd label is issued automatically.

3.14.2 Non-Weighed PLU

You can use X key for by Count, By PCS PLU without any setting.

The way of using X key is same as by-weight PLU except weighing item.

3.15 How to Change Sell By Date/Time

① Call up a PLU



② Press EDIT SELL key to enter both of effective date and time.

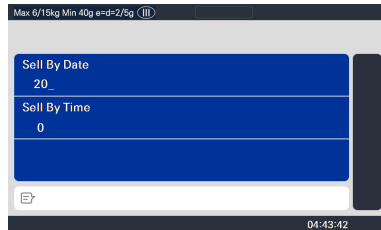

③ Press PRINT key to complete saving.

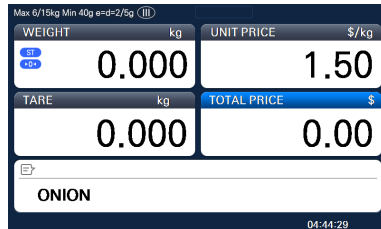

Note: - To use EDIT SELL key, you have to set this key in menu 1880 of program mode. (See chapter 2.14.8)

3.16 How to Change Origin

- ① Call up a PLU

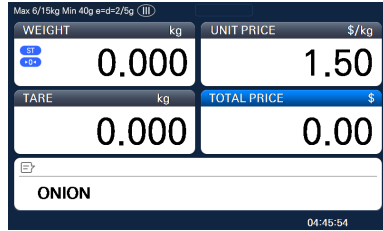

- ② Press ORIGIN key to retrieve one of origin data saved.

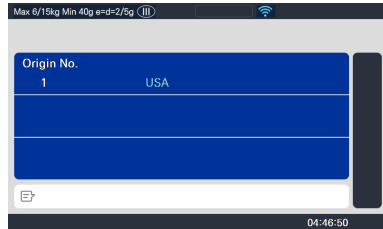

Note: - To use ORIGIN key, you have to set this key in menu 1880 of program mode. (See chapter 2.14.8)

3.17 How to Change PLU Type

Note: If you set “Save Type change” to “Y” in menu 1873 of program mode, changed PLU type is saved.
(See chapter 2.14.7)

- ① Press “WT/CT” key to change PLU type from By-weight to By-count PLU or vice versa.

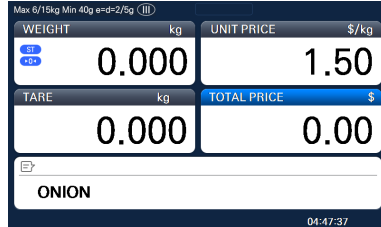

- ☞ If you change by-Weight PLU to by-count PLU, quantity is set 1 and unit price is same.
- ☞ If you change by-count PLU to by-weight PLU, unit price is same.
- ☞ If there is discount information on PLU, you can not change PLU type.

3.18 Direct Discount

If there is no discount information in PLU, you can use this function.

3.18.1 Fixed Price Key

① Call up a PLU # 1 and press “Fixed Price” key.

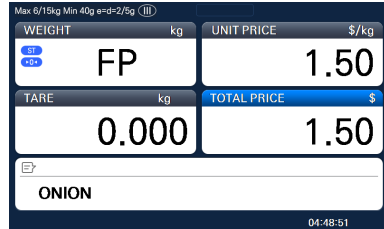

② Press “Override Key”



③ Type fixed price 2.00 than press PRINT key.



Note: - To use Fixed Price Key, you have to set this key in menu 1880 of program mode. (See chapter 2.14.8)

3.18.2 % Discount Price Key

① Call up a PLU(#1.APPLE) and press "%Discount" key

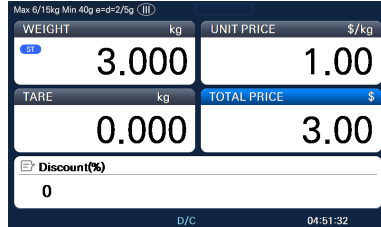

② Enter % amount to discount and press PRINT key
Ex) 20%

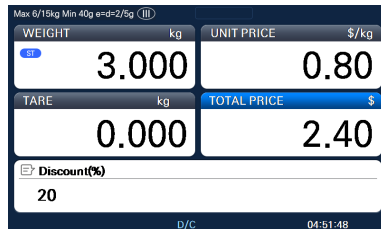

③ Place item on the platter and press PRINT key.

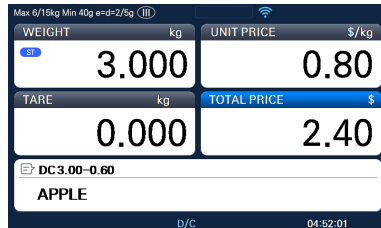

Note: - To use % DISCOUNT key, you have to set this key in menu 1880 of program mode. (See chapter 2.14.8)

3.19 PLU Connection

3.19.1 Referenced PLU Function

If you press REFERENCE key(Functions key#:9) after calling up a PLU which has reference information, reference will be shown on the display.

- ◆ To use this function, you have to set reference department and reference PLU when you create PLU.

3.19.2 Coupled PLU Function

Automatically coupled PLU is called up after transaction.
You can use this function when you sell two or more items as package.
(Does not operated in SAVE and PREPACK modes)

- ◆ To use this function, you have to set reference department and reference PLU when you create PLU.

3.19.3 Link PLU Function

Note: Operates only in the ticket mode.(Does not operated in PREPACK and AUTO modes)

When purchasing a product, it automatically purchases another product additionally

- When the Linked PLU type is weight, purchasing is made in accordance with weight

When the Linked PLU type is count, it sells 1 unit

- ◆ To use this function, you have to set Linked department and Linked PLU when you create PLU.

3.20 Sales Operation Control Parameters

3.20.1 Fixed Weight

- You can set fixed weight when you create PLU. If you call up this PLU, the weight is not changed.
- You can use IN WEIGHT key.
Call up a PLU and enter a fixed weight by using OVERRIDE key and press IN WEIGHT key.

3.20.2 Prepack Without Report

The transaction data is not added to report while using prepack mode.

- You have to set Parameter 597(Prepack report) to use this function. Also, Parameter 596 should be set to Y

APPENDIX

1. Label Format

There are fixed label format and user label format

	Fixed Label Format	User Label Format
No.	1~50	51~99
Quantity	45	20
Method	Built in CL5000	Download from PC
Features	You cannot edit format.	Using the PC program, you can program format numbers 51 to 99. In ticket mode, it is available to use Head/Tail format.

► Fixed Label Format

No	Name	Width(mm)	Length(mm)	No	Name	Width(mm)	Length(mm)
1	IS6030-00001	60	30	17	IS5653-00017	56	53
2	IS6030-00002	60	30	18	IS5054-00018	50	54
3	IS6030-00003	60	30	19	IS5054-00019	50	54
4	IS5635-00004	56	35	20	IS6051-00020	60	51
5	IS5635-00005	56	35	21	IS6051-00021	60	51
6	IS5635-00006	56	35	22	IS6060-00022	60	60
7	IS6040-00007	60	40	23	IS6060-00023	60	60
8	IS6040-00008	60	40	24	IS5068-00024	50	68
9	IS6040-00009	60	40	25	IS5068-00025	50	68
10	IS6040-00010	60	40	26	IS5068-00026	50	68
11	IS6040-00011	60	40	27	IS6063-00027	60	63
12	IS6040-00012	60	40	28	IS6063-00028	60	63
13	IS5040-00013	50	40	29	IC6040-00029	60	40
14	IS5040-00014	50	40	30	IC6040-00030	60	40
15	IS5040-00015	50	40	31	IS6040-KR001	60	40
16	IS5653-00016	56	53	32	IS6030-KR002	60	30

No	Name	Width(mm)	Length(mm)	No	Name	Width(mm)	Length(mm)
33	IS6032-KR003	60	32	40	IS6040-KR010	60	40
34	IS6060-KR004	60	60	41	IS6040-KR011	60	40
35	IS6032-KR005	60	32	42	IS6045-KR012	60	45
36	IS6042-KR006	60	42	43	IS6044-KR013	60	44
37	IS6045-KR007	60	45	44	IS6055-KR014	60	55
38	IS6050-KR008	60	50	45	IS6060-KR015	60	60
39	IS6045-KR009	60	45				

1.1 Label Format Sample

1

SWEETENED CONDENSED MILK
<VERY SWEET and STICKY>
Tare(kg): 0.100 1
20.11.05 26.11.05 1.216 32.00 38.91
PACKED ON | SELL BY | WEIGHT | UNIT PRICE | PRICE
CAS CORPORATION
+82-31-820-1100
#19 Ganap-r'i Gwang.juk-myun

2

SWEETENED CONDENSED MILK
Whole milk that had 60% of the water remove and sugar added. The amount of sugar added makes up 40% of the...
Tare(kg): 0.100 2
20.11.05 26.11.05 1.216 32.00 38.91
PACKED ON | SELL BY | WEIGHT | UNIT PRICE | PRICE
CAS CORPORATION
+82-31-820-1100
#19 Ganap-r'i Gwang.juk-myun

3

SWEETENED CONDENSED MILK
Tare(kg): 0.100 3
20.11.05 26.11.05 1.216 32.00 38.91
PACKED ON | SELL BY | WEIGHT | UNIT PRICE | PRICE
CAS CORPORATION
+82-31-820-1100
#19 Ganap-r'i Gwang.juk-myun

4

SWEETENED CONDENSED MILK
Whole milk that had 60% of the water remove and...
SELL BY \$/kg TOTAL PRICE(\$)
26.11.05 32.00 38.91
PACKED ON NET WT.kg
20.11.05 1.216
Thank You
CAS CORPORATION
+82-31-820-1100
#19 Ganap-r'i Gwang.juk-myun

5

SWEETENED CONDENSED MILK
Whole milk that had 60% of the water remove and sugar added. The amount of sugar added makes up 40% of the sweetened condensed milks volume. It is very...
SELL BY \$/kg TOTAL PRICE(\$)
26.11.05 32.00 38.91
PACKED ON NET WT.kg
20.11.05 1.216
Thank You
CAS CORPORATION
+82-31-820-1100
#19 Ganap-r'i Gwang.juk-myun

6

SWEETENED CONDENSED MILK
Whole milk that had 60% of the water remove and...
SELL BY \$/kg TOTAL PRICE(\$)
26.11.05 32.00 38.91
PACKED ON NET WT.kg
20.11.05 1.216
Thank You
CAS CORPORATION
+82-31-820-1100
#19 Ganap-r'i Gwang.juk-myun

7

SWEETENED CONDENSED MILK
<VERY SWEET and STICKY>

0 102007 038915

Tare(kg) : 0.100

20.11.05 26.11.05

PACKED ON SELL BY

UNIT PRICE \$/kg 32.00 WEIGHT kg 1.216

38.91

TOTAL PRICE \$

CAS CORPORATION
 +82-31-820-1100
 #19 Ganap-ri Gwangjuk-myun

8

SWEETENED CONDENSED MILK
 Whole milk that had 60% of the water remove and sugar added. The amount of sugar added makes up 40% of the

0 102008 038914

Tare(kg) : 0.100

20.11.05 26.11.05

PACKED ON SELL BY

UNIT PRICE \$/kg 32.00 WEIGHT kg 1.216

38.91

TOTAL PRICE \$

CAS CORPORATION
 +82-31-820-1100
 #19 Ganap-ri Gwangjuk-myun

9

SWEETENED CONDENSED MILK

0 102009 038913

Tare(kg) : 0.100

20.11.05 26.11.05

PACKED ON SELL BY

UNIT PRICE \$/kg 32.00 WEIGHT kg 1.216

38.91

TOTAL PRICE \$

CAS CORPORATION
 +82-31-820-1100
 #19 Ganap-ri Gwangjuk-myun

10

SWEETENED CONDENSED MILK
<VERY SWEET and STICKY>

0 102010 038919

Tare(kg) : 0.100

20.11.05 26.11.05

PACKED ON SELL BY WEIGHT

UNIT PRICE 32.00 PRICE **38.91**

CAS CORPORATION
 +82-31-820-1100
 #19 Ganap-ri Gwangjuk-myun

11

SWEETENED CONDENSED MILK
 Whole milk that had 60% of the water remove and sugar added. The amount of sugar added makes up 40% of the

0 102011 038918

Tare(kg) : 0.100

20.11.05 26.11.05

PACKED ON SELL BY WEIGHT

UNIT PRICE 32.00 PRICE **38.91**

CAS CORPORATION
 +82-31-820-1100
 #19 Ganap-ri Gwangjuk-myun

12

SWEETENED CONDENSED MILK

0 102012 038917

Tare(kg) : 0.100

20.11.05 26.11.05

PACKED ON SELL BY WEIGHT

UNIT PRICE 32.00 PRICE **38.91**

CAS CORPORATION
 +82-31-820-1100
 #19 Ganap-ri Gwangjuk-myun

13

SWEETENED CONDENSED
<VERY SWEET and STICKY>

0 102013 038916

Tare(kg) : 0.100

20.11.05 26.11.05

PACKED ON SELL BY

NET WT. (kg) 1.216 PRICE / kg \$ 32.00 TOTAL PRICE \$ **38.91**

CAS CORPORATION
 +82-31-820-1100
 #19 Ganap-ri

14

SWEETENED CONDENSED
 Whole milk that had 60% of the water remove and sugar added. The amount of sugar added

0 102014 038915

Tare(kg) : 0.100

20.11.05 26.11.05

PACKED ON SELL BY

NET WT. (kg) 1.216 PRICE / kg \$ 32.00 TOTAL PRICE \$ **38.91**

CAS CORPORATION
 +82-31-820-1100
 #19 Ganap-ri

SWEETENED CONDENSED

PACKED ON 20.11.05
SELL BY 26.11.05

0 102015 038914
Tare (kg): 0.100

1.216 32.00 **38.91**

NET WT. (kg) PRICE / kg (\$) TOTAL PRICE (\$)

CAS CORPORATION
+82-31-820-1100
#19 Ganap-ri

15

SWEETENED CONDENSED MILK
<VERY SWEET and STICKY>

Whole milk that had 60% of the water remove and sugar added. The amount of sugar added makes up 40% of the sweetened condensed milks volume. It is very sweet and sticky and adds a richness to the foods it is added to. It is used to make candies, bars, pies, and puddings. Sweetened condensed milk turns a

PACKED ON 20.11.05
SELL BY 26.11.05

0 102016 038913

1.216 32.00 **38.91**

NET WT./kg TOTAL PRICE(\$)

Thank You
CAS CORPORATION
+82-31-820-1100
#19 Ganap-ri Gwangjuk-myun

16

SWEETENED CONDENSED MILK

Whole milk that had 60% of the water remove and sugar added. The amount of sugar added makes up 40% of the sweetened condensed milks volume. It is very sweet and sticky and adds a richness to the foods it is added to. It is used to make candies, bars, pies, and puddings. Sweetened condensed milk turns a

PACKED ON 20.11.05
SELL BY 26.11.05

0 102017 038912

1.216 32.00 **38.91**

NET WT. (kg) PRICE / kg (\$) TOTAL PRICE (\$)

Thank You
CAS CORPORATION
+82-31-820-1100
#19 Ganap-ri Gwangjuk-myun

17

SWEETENED CONDENSED MILK
<VERY SWEET and STICKY>

Whole milk that had 60% of the water remove and sugar added. The amount of sugar added makes up 40% of the sweetened condensed milks volume. It is very sweet and sticky and adds a richness to the foods it is added to. It is used to make candies, bars, pies, and puddings. Sweetened condensed milk turns a

PACKED ON 20.11.05
SELL BY 26.11.05

0 102018 038911

1.216 32.00 **38.91**

NET WT. (kg) PRICE / kg (\$) TOTAL PRICE (\$)

CAS CORPORATION
+82-31-820-1100
#19 Ganap-ri

18

SWEETENED CONDENSED

Whole milk that had 60% of the water remove and sugar added. The amount of sugar added makes up 40% of the sweetened condensed milks volume. It is very sweet and sticky and adds a richness to the foods it is added to. It is used to make candies, bars, pies, and puddings. Sweetened condensed milk turns a

PACKED ON 20.11.05
SELL BY 26.11.05

0 102019 038910

1.216 32.00 **38.91**

NET WT. (kg) PRICE / kg (\$) TOTAL PRICE (\$)

CAS CORPORATION
+82-31-820-1100
#19 Ganap-ri

19

SWEETENED CONDENSED MILK
<VERY SWEET and STICKY>

Whole milk that had 60% of the water remove and sugar added. The amount of sugar added makes up 40% of the sweetened condensed milks volume. It is very sweet and sticky and adds a richness to the foods it is added to.

PACKED ON 20.11.05
SELL BY 26.11.05

0 102020 038916

1.216 32.00 **38.91**

NET WT. (kg) PRICE / kg (\$) TOTAL PRICE (\$)

CAS CORPORATION
+82-31-820-1100
#19 Ganap-ri Gwangjuk-myun

20

SWEETENED CONDENSED MILK

Whole milk that had 60% of the water remove and sugar added. The amount of sugar added makes up 40% of the sweetened condensed milks volume. It is very sweet and sticky and adds a richness to the foods It is added to.

PACKED ON 20.11.05
SELL BY 26.11.05

0 102021 038913

1.216 32.00 38.91

NET WT. kg PRICE / kg \$ TOTAL PRICE \$

CAS CORPORATION
+82-31-820-1100
#19 Ganap-ri Gwangjuk-myun

21

SWEETENED CONDENSED MILK
<VERY SWEET and STICKY>

Whole milk that had 60% of the water remove and sugar added. The amount of sugar added makes up 40% of the sweetened condensed milks volume. It is very sweet and sticky and adds a richness to the foods It is added to. It is used to make candies, bars, pies, and puddings. Sweetened condensed milk turns a golden color and takes on a caramel like flavor when heated. It is also thickens as it is heate

PACKED ON 20.11.05 SELL BY 26.11.05 WEIGHT 1.216

0 102022 038914 22

0.100 32.00 38.91

UNIT PRICE PRICE

CAS CORPORATION
+82-31-820-1100
#19 Ganap-ri Gwangjuk-myun

22

SWEETENED CONDENSED MILK

Whole milk that had 60% of the water remove and sugar added. The amount of sugar added makes up 40% of the sweetened condensed milks volume. It is very sweet and sticky and adds a richness to the foods It is added to. It is used to make candies, bars, pies, and puddings. Sweetened condensed milk turns a golden color and takes on a caramel like flavor when heated. It is also thickens as it is heate

PACKED ON 20.11.05 SELL BY 26.11.05 WEIGHT 1.216

0 102023 038913 23

0.100 32.00 38.91

UNIT PRICE PRICE

CAS CORPORATION
+82-31-820-1100
#19 Ganap-ri Gwangjuk-myun

23

SWEETENED CONDENSED
<VERY SWEET and STICKY>

Whole milk that had 60% of the water remove and sugar added. The amount of sugar added makes up 40% of the sweetened condensed milks volume. It is very sweet and sticky and adds a richness to the foods It is added to. It is used to make candies, bars, pies, and puddings. Sweetened condensed milk turns a golden color and takes on a caramel like flavor when heated. It is also thickens as it is heate

PACKED ON 20.11.05
SELL BY 26.11.05

0 102024 038912

Tare (kg): 0.100

1.216 32.00 38.91

NET WT. kg PRICE / kg \$ TOTAL PRICE \$

CAS CORPORATION
+82-31-820-1100
#19 Ganap-ri

24

SWEETENED CONDENSED

Whole milk that had 60% of the water remove and sugar added. The amount of sugar added makes up 40% of the sweetened condensed milks volume. It is very sweet and sticky and adds a richness to the foods It is added to. It is used to make candies, bars, pies, and puddings. Sweetened condensed milk turns a golden color and takes on a caramel like flavor when heated. It is also thickens as it is heate

PACKED ON 20.11.05
SELL BY 26.11.05

0 102025 038911

Tare (kg): 0.100

1.216 32.00 38.91

NET WT. kg PRICE / kg \$ TOTAL PRICE \$

CAS CORPORATION
+82-31-820-1100
#19 Ganap-ri

25

SWEETENED CONDENSED
<VERY SWEET and STICKY>

Whole milk that had 60% of the water remove and sugar added. The amount of sugar added makes up 40% of the sweetened condensed milks volume. It is very sweet and sticky and adds a richness to the foods It is added to. It is used to make candies, bars, pies, and puddings. Sweetened condensed milk turns a golden color and takes on a caramel like flavor when heated. It is also thickens as it is heate

PACKED ON 20.11.05
SELL BY 26.11.05

0 102026 038910

Tare (kg): 0.100

1.216 32.00 38.91

NET WT. kg PRICE / kg \$ TOTAL PRICE \$

CAS CORPORATION
+82-31-820-1100
#19 Ganap-ri

26

SWEETENED CONDENSED MILK
<VERY SWEET and STICKY>

Whole milk that had 60% of the water remove and sugar added. The amount of sugar added makes up 40% of the sweetened condensed milks volume. It is very sweet and sticky and adds a richness to the foods It is added to. It is used to make candies, bars, pies, and puddings. Sweetened condensed milk turns a golden color and takes on a caramel like flavor when heated. It is also thickens as it is heated

PACKED ON 20.11.05
 SELL BY 26.11.05

0 102027 03891 9

1.216 32.00 38.91

NET WT. (6) PRICE / kg (9) TOTAL PRICE (3)

CAS CORPORATION
 +82-31-820-1100
 #19 Ganap-ri Gwangjuk-myun

27

SWEETENED CONDENSED MILK

Whole milk that had 60% of the water remove and sugar added. The amount of sugar added makes up 40% of the sweetened condensed milks volume. It is very sweet and sticky and adds a richness to the foods It is added to. It is used to make candies, bars, pies, and puddings. Sweetened condensed milk turns a golden color and takes on a caramel like flavor when heated. It is also thickens as it is heated

PACKED ON 20.11.05
 SELL BY 26.11.05

0 102028 03891 8

1.216 32.00 38.91

NET WT. (6) PRICE / kg (9) TOTAL PRICE (3)

CAS CORPORATION
 +82-31-820-1100
 #19 Ganap-ri Gwangjuk-myun

28

TOTAL

20.11.05 16:49 TRANSACTION 5

0 100000 200964

TOTAL PRICE \$ 200.96

CAS CORPORATION
 +82-31-820-1100
 #19 Ganap-ri Gwangjuk-myun

29

SWEETENED CONDENSED MILK
<VERY SWEET and STICKY>

Whole milk that had 60% of the water remove and sugar added. The amount of sugar added makes up 40% of the sweetened condensed milks volume. It is very sweet and sticky and adds a richness to the foods It is added to. It is used to make candies, bars, pies, and puddings. Sweetened condensed milk turns a golden color and takes on a caramel like flavor when heated. It is also thickens as it is heated

PACKED ON 20.11.05 16:32 SELL BY 26.11.05 16:32

0 102030 03891 3

1.216 32.00 38.91

PRICE \$/kg TOTAL PRICE \$

CAS CORPORATION
 +82-31-820-1100 #19 Ganap-ri Gwangjuk-myun Yangju-gun

30

SWEETENED CONDENSED MILK
<VERY SWEET and STICKY>

UNIT PRICE 32.00 WEIGHT 1.216

0 102031 03891 2

20.11.05 16:32 26.11.05 16:32 38.91

PACKED ON SELL BY TOTAL PRICE

CAS CORPORATION
 +82-31-820-1100
 #19 Ganap-ri Gwangjuk-myun

31

SWEETENED CONDENSED MILK
<VERY SWEET and STICKY>

16:32 16:32 32 38.91

20.11.05 26.11.05 1.216 32.00

PACKED ON | SELL BY | WEIGHT | UNIT PRICE | PRICE

CAS CORPORATION
 +82-31-820-1100
 #19 Ganap-ri Gwangjuk-myun

32

SWEETENED CONDENSED MILK
<VERY SWEET and STICKY>

UNIT PRICE 32.00 WEIGHT 1.216

0 102033 03891 0

20.11.05 16:32 26.11.05 16:32 38.91

PACKED ON SELL BY TOTAL PRICE

CAS CORPORATION
 +82-31-820-1100
 #19 Ganap-ri Gwangjuk-myun

33

0 102034 03891 0 34

SWEETENED CONDENSED MILK
<VERY SWEET and STICKY>

Whole milk that had 60% of the water remove and sugar added. The amount of sugar added makes up 40% of the sweetened condensed milks volume. It is very sweet and sticky and adds a richness to the foods It is added to. It is used to make candies, bars, pies, and puddings. Sweetened condensed milk turns a golden color and takes on a caramel like flavor when heated. It is also thickens as it is heated

16:32 16:32 32 38.91

20.11.05 26.11.05 1.216 32.00

PACKED ON | SELL BY | WEIGHT | UNIT PRICE | PRICE

CAS CORPORATION
 +82-31-820-1100
 #19 Ganap-ri Gwangjuk-myun

34

35

SWEETENED CONDENSED MILK
 <VERY SWEET and STICKY>

PACKED ON	SELL BY	UNIT PRICE	WEIGHT
20.11.05	26.11.05	32.00	1.216
		16:32	35
			PRICE
38.91			

0 102039 038918

CAS CORPORATION
 +82-31-820-1100
 #19 Ganap-ri Gwangjuk-myun

36

SWEETENED CONDENSED MILK
 <VERY SWEET and STICKY>

PACKED ON	SELL BY	UNIT PRICE	WEIGHT
20.11.05	26.11.05	32.00	1.216
			36
			PRICE
38.91			

0 102036 038917

CAS CORPORATION
 +82-31-820-1100
 #19 Ganap-ri Gwangjuk-myun

37

SWEETENED CONDENSED MILK
 <VERY SWEET and STICKY>

		UNIT PRICE	WEIGHT
		32.00	1.216
			37
			PRICE
38.91			

0 12037003891003200

20.11.05 16:32 26.11.05 16:32

PACKED ON	SELL BY	TOTAL PRICE
20.11.05	26.11.05	16:32

CAS CORPORATION
 +82-31-820-1100
 #19 Ganap-ri Gwangjuk-myun

38

SWEETENED CONDENSED MILK
 <VERY SWEET and STICKY>

		UNIT PRICE	WEIGHT
		32.00	1.216
			38
			PRICE
38.91			

0 12038003891003200

20.11.05 16:32 26.11.05 16:32

PACKED ON	SELL BY	TOTAL PRICE
20.11.05	26.11.05	16:32

CAS CORPORATION
 +82-31-820-1100
 #19 Ganap-ri Gwangjuk-myun

39

SWEETENED CONDENSED MILK
 <VERY SWEET and STICKY>

		UNIT PRICE	WEIGHT
		32.00	1.216
			39
			PRICE
38.91			

0 102039 038914

20.11.05 16:32 26.11.05 16:32

PACKED ON	SELL BY	TOTAL PRICE
20.11.05	26.11.05	16:32

CAS CORPORATION
 +82-31-820-1100
 #19 Ganap-ri Gwangjuk-myun

40

SWEETENED CONDENSED MILK
 Whole milk that had 60% of the water remove and sugar added. The amount of sugar added makes up 40% of the

		UNIT PRICE	WEIGHT
		32.00	1.216
			40
			PRICE
38.91			

0 102040 038916

20.11.05 16:32 26.11.05 16:32

PACKED ON	SELL BY	TOTAL PRICE
20.11.05	26.11.05	16:32

CAS CORPORATION
 +82-31-820-1100
 #19 Ganap-ri Gwangjuk-myun

41

SWEETENED CONDENSED MILK
 Whole milk that had 60% of the water remove and sugar added. The amount of sugar added makes up 40% of the sweetened condensed milk volume. It is very sweet and

		UNIT PRICE	WEIGHT
		32.00	1.216
			41
			PRICE
38.91			

0 102041 038919

20.11.05 16:32 26.11.05 16:32

PACKED ON	SELL BY	TOTAL PRICE
20.11.05	26.11.05	16:32

CAS CORPORATION
 +82-31-820-1100
 #19 Ganap-ri Gwangjuk-myun

42

SWEETENED CONDENSED MILK
 <VERY SWEET and STICKY>
 Whole milk that had 60% of the water remove and sugar added. The amount of sugar added makes up 40% of the

		UNIT PRICE	WEIGHT
		32.00	1.216
			42
			PRICE
38.91			

0 102042 038918

20.11.05 16:32 26.11.05 16:32

PACKED ON	SELL BY	TOTAL PRICE
20.11.05	26.11.05	16:32

CAS CORPORATION
 +82-31-820-1100
 #19 Ganap-ri Gwangjuk-myun

43

SWEETENED CONDENSED MILK
<VERY SWEET and STICKY>
 Whole milk that had 60% of the water remove and sugar added. The amount of sugar added makes up 40% of the

PACKED ON	SELL BY	UNIT PRICE	WEIGHT
20.11.05	26.11.05	32.00	1.216
		16:32	PRICE 43
			38.91

0 102043 038917

CAS CORPORATION
 +82-31-820-1100
 #19 Ganap-ti GwangJuk-myun

44

SWEETENED CONDENSED MILK
 Whole milk that had 60% of the water remove and sugar added. The amount of sugar added makes up 40% of the sweetened condensed milks volume. It is very sweet and sticky and adds a richness to the foods It is added to.

PACKED ON	SELL BY	UNIT PRICE	WEIGHT
20.11.05	26.11.05	32.00	1.216
		16:32	PRICE 44
			38.91

0 102044 038918

CAS CORPORATION
 +82-31-820-1100
 #19 Ganap-ti GwangJuk-myun

45

SWEETENED CONDENSED MILK
 Whole milk that had 60% of the water remove and sugar added. The amount of sugar added makes up 40% of the sweetened condensed milks volume. It is very sweet and sticky and adds a richness to the foods It is added to. It is used to make candies, bars, pies, and puddings. Sweetened condensed milk turns a golden color and takes

PACKED ON	SELL BY	UNIT PRICE	WEIGHT
20.11.05	26.11.05	32.00	1.216
		16:32	PRICE 45
			38.91

0 102045 038915

CAS CORPORATION
 +82-31-820-1100
 #19 Ganap-ti GwangJuk-myun

1.2 Label Format's field Sample

► (1) Label sample 1

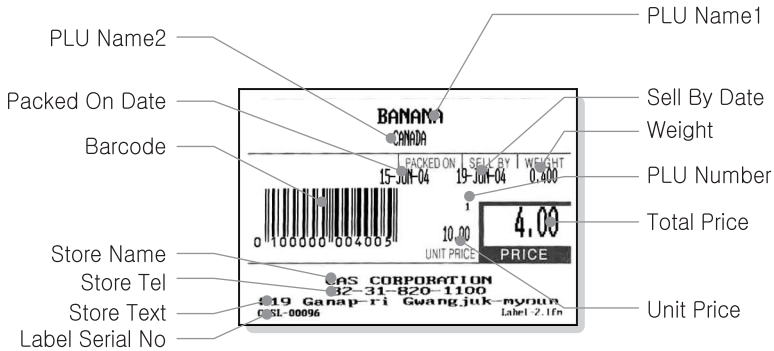

► (2) Label sample 2

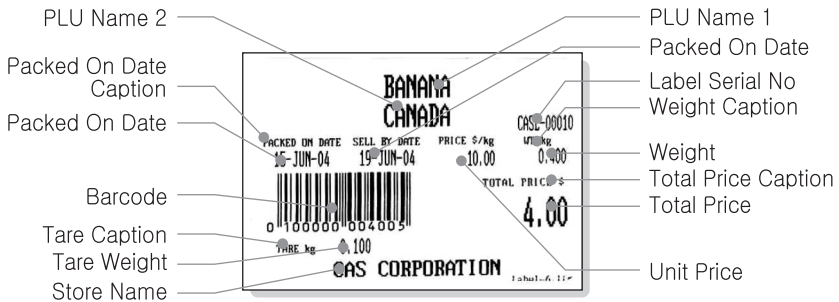

2. ASCII Code Table

► Microsoft Window Codepage 1252

	00	01	02	03	04	05	06	07	08	09	0A	0B	0C	0D	0E	0F
00	NUL 0000	STX 0001	SOT 0002	ETX 0003	EOT 0004	ENQ 0005	ACK 0006	BEL 0007	BS 0008	HT 0009	LF 000A	VT 000B	FF 000C	CR 000D	SO 000E	SI 000F
10	DLE 0010	DC1 0011	DC2 0012	DC3 0013	DC4 0014	NAK 0015	SYN 0016	ETB 0017	CAN 0018	EM 0019	SUB 001A	ESC 001B	FS 001C	GS 001D	RS 001E	US 001F
20	SP 0020	!	"	#	\$	%	&	'	()	*	+	,	-	.	/
30	0 0030	1 0031	2 0032	3 0033	4 0034	5 0035	6 0036	7 0037	8 0038	9 0039	:	;	<	=	>	?
40	@ 0040	A 0041	B 0042	C 0043	D 0044	E 0045	F 0046	G 0047	H 0048	I 0049	J 004A	K 004B	L 004C	M 004D	N 004E	O 004F
50	P 0050	Q 0051	R 0052	S 0053	T 0054	U 0055	V 0056	W 0057	X 0058	Y 0059	Z 005A	[005B	\ 005C] 005D	^ 005E	_ 005F
60	` 0060	a 0061	b 0062	c 0063	d 0064	e 0065	f 0066	g 0067	h 0068	i 0069	j 006A	k 006B	l 006C	m 006D	n 006E	o 006F
70	p 0070	q 0071	r 0072	s 0073	t 0074	u 0075	v 0076	w 0077	x 0078	y 0079	z 007A	{ 007B	 007C	}	~ 007E	DEL 007F
80	€ 20AC		ƒ 201A	„ 0192	“ 201E	… 2026	† 2020	‡ 2021	ˆ 02C6	% 2030	Š 0160	< 2039	Œ 0152		Ž 017D	
90		˘ 2018	˙ 2019	˚ 201C	˛ 201D	• 2022	— 2013	— 2014	* 02DC	™ 2122	š 0161	> 203A	œ 0153		ž 017E	ÿ 0178
A0	NBSP 00A0	¡ 00A1	¢ 00A2	£ 00A3	¤ 00A4	¥ 00A5	¦ 00A6	§ 00A7	¨ 00A8	© 00A9	ª 00AA	« 00AB	¬ 00AC	­ 00AD	® 00AE	¯ 00AF
B0	° 00B0	± 00B1	² 00B2	³ 00B3	´ 00B4	µ 00B5	¶ 00B6	· 00B7	¸ 00B8	¹ 00B9	º 00BA	» 00BB	¼ 00BC	½ 00BD	¾ 00BE	¿ 00BF
C0	À 00C0	Á 00C1	Â 00C2	Ã 00C3	Ä 00C4	Å 00C5	Æ 00C6	Ç 00C7	È 00C8	É 00C9	Ê 00CA	Ë 00CB	Ì 00CC	Í 00CD	Î 00CE	Ï 00CF
D0	Ð 00D0	Ñ 00D1	Ò 00D2	Ó 00D3	Ô 00D4	Õ 00D5	Ö 00D6	× 00D7	Ø 00D8	Ù 00D9	Ú 00DA	Û 00DB	Ü 00DC	Ý 00DD	Þ 00DE	ß 00DF
E0	à 00E0	á 00E1	â 00E2	ã 00E3	ä 00E4	å 00E5	æ 00E6	ç 00E7	è 00E8	é 00E9	ê 00EA	ë 00EB	ì 00EC	í 00ED	î 00EE	ï 00EF
F0	ð 00F0	ñ 00F1	ò 00F2	ó 00F3	ô 00F4	õ 00F5	ö 00F6	÷ 00F7	ø 00F8	ù 00F9	ú 00FA	û 00FB	ü 00FC	ý 00FD	þ 00FE	ÿ 00FF

Note: To enter A , first you have to read 40 in a row and 01 in a column and type 41.

3. Window Character Set Information

Code	Short Name	Description	Country
1250	Central Europe	Windows Latin 2	Albania, Croatia, Czech, Faeroese, Hungarian, Polish, Romanian, Serbian(Latin), Slovak, Slovenian
1251	Cyrillic	Windows Cyrillic (Slavic)	Byelorussian, Bulgarian, Russian, Ukrainian
1252	Latin 1	Windows Latin 1 (ANSI)	Afrikaans, Catalan, Danish, Dutch, English, USA, Canada, New Zealand, Austria, Ireland, South Africa, Finnish, French, Belgium, Switzerland, Luxembourg, German, Austria, Liechtenstein, Italian, Icelandic, Indonesian, Norwegian, Portuguese, Brazil, Spanish, Mexico, Swedish
1253	Greek	Windows Greek	Greek
1254	Turkish	Windows Latin 5 (Turkish)	Turkish
1255	Hebrew	Windows Hebrew	Hebrew
1256	Arabic	Windows Arabic	Saudi Arabia, Iraq, Egypt, Libya, Algeria, Morocco, Tunisia, Oman, Yemen, Syria, Jordan, Lebanon, Kuwait, United Arab Emirates, Bahrain, Qatar, Farsi
1257	Baltic	Windows Baltic Rim	Estonian, Latvian, Lithuanian
1258	Vietnam		Vietnam
874	Thai		Thai
932	Japanese Shift-JIS		Japan
936	Simplified Chinese GBK	Simplified Chinese	Chinese, Singapore
949	Korean	Complete Hangul	Korea
950	Traditional Chinese BIG5	Traditional Chinese	Taiwan, HongKong

4. Error Message

Critical Error Message		
Message	Description	Solution
ADM NOT IN CODE	CODE 01, 02 : ADM communication error CODE 03 : ADM initialization error CODE 04 : ADM setting value error	Inquire of A/S center
Invalid AD Module	A/D failure upon initial zero checking(Communication disabled)	Inquire of A/S center
AD Error(EEPROM)	A/D setting value(EEPROM Data) abnormality Error Message upon initial zero checking	Inquire of A/S center
Check AD Communication	Check AD Communication	Inquire of A/S center
A/D – Init Status Error	ADM setting value error	Inquire of A/S center
A/D – EEP Data Error	A/D setting value (EEPROM Data) abnormality Error Message. A/D Error upon calibration	Inquire of A/S center
A/D – Conversion Error	AD Conversion Error	Inquire of A/S center
.Check Memory Table Error..	Memory checking disabled upon scale booting	Inquire of A/S center
.Init AD Module Error..	AD module checking disabled upon scale booting	Inquire of A/S center
.Network Check Error	Network checking disabled upon scale booting	Inquire of A/S center
Cal Error – Unstable	Weight not stabilized upon Span Calibration or linearity adjusting	Inquire of A/S center
Cal Error – Range Over	Weight going out of tolerance upon Span Calibration or linearity adjusting	Inquire of A/S center
Cal Error – Wrong ADM	A/D Module abnormality (Communication failure, no module , unstable A/D ,etc.) upon Span Calibration or linearity adjusting	Inquire of A/S center
Undefined Key	Undefined Key (Incorrect Map of keypad)	Inquire of A/S center
Undefined Parameter	Parameter not defined or not usable	Inquire of A/S center

Error Message		
Message	Description	Solution
Wrong MAC	When MAC address is not registered using a new network card. When using a new network card,	Register the MAC address in Menu 1940.
Setting Error	When wireless network setting is not properly executed upon using new network card	Try again after the setting is changed in Menu 1913(IP) as follows IP : [010.010.003.033] G/W : [010.010.000.001] SMASK : [255.255.000.000] TCP Port : [20304]
Zero Range Error	A/D Zero Range Error Going out of zero passing range upon initial zero checking	Remove objects that may be on tray of scale, and place tray when there is no tray.
UNSTABLE	When scale is not stabilized or weight is not stabilized upon tare setting	Adjust level for scale using a level after installing scale at a place with no shaking

Status Message	
Message	Description
[NO PLU NAME]	Message appearing when there is no name for PLU
Add memory full	Message appearing as no sales occur when the buffer is filled up with data
Can after delete D/C	Can after delete D/C Message appearing when there exist Discount data in PLU to be deleted upon deletion of PLU from Menu 1147
CAN NOT REOPEN! (1)~(3)	Message appearing when issued ticket cannot be reopened -(1) When ticket to be opened does not exist -(2) When Clerk number in ticket to be opened does not agree -(3) Message appearing when the space to be Reopened is insufficient
Cannot Discount	Discount is not applicable when Menu 1131, PLU is set as Fixed Price
Permission Denied	Check for Permission Level when Permission Level is low
Undefined Parameter	Parameter not defined or not usable
Cannot Delete Dept No 1	Menu 1213, Department No.1 cannot be deleted.
Remained D/C PLU	Delete PLU per department when there exist Discount data in PLU upon deletion of, whole PLU
Already printed	Message displayed when the same PLU is printed after calling and printing PLU. Issued after re-calling PLU. However, excluded in Prepack mode
Already Tare	When tare setting is attempted with set tare available (Limited to the cases with continuous tare being limited)

Are you sure? (1=Y/ 0= N) Warning : Paper Type is Label	Message of being asked when printing on Label Paper is desired in Z Report (1=Yes, 0=No)
Changed to LABEL	When changed to Label Mode using TICKET / LABEL key
Changed to TICKET	When changed to TICKET Mode using TICKET / LABEL key
Check key tare	When Key tare is set, PLU with Tare information cannot be called Dismantle Key tare and call PLU.
Check minimum Weight	When weights smaller than minimum weight of scale are sold
Check PLU tare	If PLU Tare are available, check PLU tare when Tare is set.
Check PLU type	Message appearing when weight product is registered in Menu 1451, Job batch (Only count products allowed for use)
Check price	When the issuance key is pushed at total amount of 0 1. When unit price is Zero -> Set [parameter 581] if only weight is to be outputted 2. When total amount is Zero -> Printing is not allowed when total amount is Zero
Check sales summary overflow	Summary overflow, Message appearing when the memory storing PLU SALE SUMMARY is filled up
Check weight tare	Weight Tare is set, remove the set Tare value when .PLU with PLU Tare is called
Check Unit Weight	Check Unit Weight When the unit weight(unit price-based weight) cannot be changed
Check weight	When the weight is 0 upon issuance of label
CLERK IS OPENED!	Message appearing if other clerk is called when clerk information on sale exists
CLERK SUMMARY OFF	Message appearing when calculation for total sum is not executed without using Add (Allowed only in Standard Clerk mode)
CLERK SUMMARY ON	Message appearing when calculation for total sum is executed without using Add (Allowed only in Standard Clerk mode)
Convert Unit:XXXX	Unit weight displayed when the unit price is changed XXXX = 1 kg, 100 g, 1 lb, 1/2 lb, 1/4 lb
Do you want to print on label? 1=Yes, 0=No	Message of being asked when printing on Label Paper in X Report or printing of Table list on Label Paper is desired (1=Yes, 0=No)
Double print(auto)	Double print (Auto mode) Shows automatic issuance of 2 sheets
Incongruous Paper	When incorrect printing paper is inserted
Invalid PLU Type	Displayed when the relevant PLU is called after selecting 1 for Fixed Price in Menu 1120, PLU input item
Invalid Tare Value	When inputted weight does not conform to value of one graduation (Interval) upon Key tare setting, please check for Tare regulations of Tare.

Invalid Value	Invalid Value
Last PLU voided	Message informing cancellation of the product sold last
Log in clerk	Message appearing when Clerk Login is required
MAX TRNASACTION IS 50!	MAX TRNASACTION IS 50! Message appearing when the maximum number of sold units per Clerk exceeds 50ea
Check minimum weight	Check minimum weight
Check PLU	Check PLU
Multiple unit PLU	Override n Override not allowed when two types of Override error., Weight Unit are used
Negative ON	When Negative sales are executed
Negative PLU	Negative PLU
Net - Err	Network error
Net - Pfull	Network error (Pay buffer is filled up with data)
Net - Sfull	Network error (Sale buffer is filled up with data)
Network LOCK	Network LOCK
No Currency data	No Currency data
No data	1. No data 2.. No sales data in void Last Sale 3. No Data in Table
No Data or Table	No Data or Table
No down tare	Tare lower than the set Tare cannot be set upon continuous use of Tare
No grand total price	No grand total price
No label, No summary	No label, No summary Only account balancing is entered without outputting of labels or total add
NO MASTER	Master disconnected
No reference	No reference information exists in relevant PLU when Function key(PLU REFERENCE, #9) is pushed after calling PLU
No sale in floating	Message appearing under the conditions of not allowing sales in Floating mode [ADD] "Message of operation disabled when Add is operated in Clerk mode"
No Tare	When Tare clearing was attempted without set Tare
No up tare	Tare higher than the set Tare cannot be set upon continuous use of Tare
No X key on negative	Multiply Negative is not allowed when Multiply print is attempted using -> "X" key after setting Negative ON.

Not found	1. Not found customer. : When Customer cannot be found in credit sale 2. Not Found clerk. : Message appearing when Clerk is not set
Open TPH	When printing is attempted under the condition with printer Head being open -> Close Head of the printer
Overload!	Maximum weight of scale exceeded, check for maximum weight of the scale
Paper End	Paper End, Replace paper.
Press FEED	When issuance is desired without paper, set paper position by pushing FEED key after replacing paper.
PEEL - OFF	When printing is attempted under the condition with printed paper hung up at printer inlet or label not removed, automatic printing occurs if printed paper or hung-up label is removed
PLU exist !!	When PLU Copy, Move is to be executed , PLU exists at the place for copy or move
PLU Not Found!	No PLU available for the relevant number.
Remove weight on tray	When weight is placed on tray upon sales of By PCS, By Count PLU: Remove weight on tray.
REOPEN OK!	Reopen success.
Select label mode	Direction message in Receipt mode in the case of [PREPACK]
TareLimit OverRange	When Tare weight exceeded the maximum weight of scale Tare, please check for the maximum Tare value of scale.
Wrong weight value	Message appearing upon inputting fixed weight or values not complying with regulations
BACKUP FAIL!	When USB memory is not connected. Check USB memory connection status,
UPDATE FAIL!	When USB Memory is not connected. When backup file does not exist in the USB memory. Check memory connection status or file status in USB memory.

CN1

Label Printing Scale



CAS BLDG., #1315, YANGJAE-DAERO,
GANGDONG-GU, SEOUL, KOREA

TEL_ 82 2 2225 3500

FAX_ 82 2 475 4668

www.globalcas.com



9002PCN00330